



Fiber Optic Communications

Ch 2. Optical Transmitters



Contents

- Introduction
- Ch 1 - Optical fiber
- **Ch 2 - Optical transmitters**
- Ch 3 - Optical receivers
- Ch 4 - Optical amplifiers
- Ch 5 - Dispersion Management
- Ch 6 - Multichannel Systems
- Ch 7 - Optical access systems
- Ch 8 - Other optical systems



Optical Transmitter

Optical transmitters

- Requirements (Power, Modulation response, Bandwidth)
 - Small physical dimensions to suit the fiber
 - Narrow **beam width** to suit fiber NA
 - Narrow **spectral width** (or line width) to reduce chromatic dispersion
 - Fast **response time** (high bandwidth) to support high bit rate
 - High **output power** into the fiber for long reach without repeaters
 - Ability to **directly modulate** by varying driving current
 - **Linearity** (output light power proportional to driving current) →

important for analog systems

- **Stability** (LED better than LASER)
- **Reliability** (life time) and **cost**
- Driving circuit issues → impedance matching

Laser vs. LED overview

- Light-emitting diode (LED) - Simple forward biased PN junction
 - Based on spontaneous emission
 - Incoherent light
 - Linewidth $\Delta\nu \approx 10$ THz ($\Delta\lambda = 10\text{--}100$ nm) modulation response
 - Slow response time
 - Much larger linewidth than data rate \Rightarrow dispersive limitations
- Laser (achieve stimulated emission):
 - Based on stimulated emission
 - Highly coherent light
 - Bandwidth
 - Linewidth $\Delta\nu = 0.1\text{--}10$ MHz
 - Fast response time
 - Usually much smaller linewidth than data rate

Optical Transmitter

Photon processes in light-matter interaction

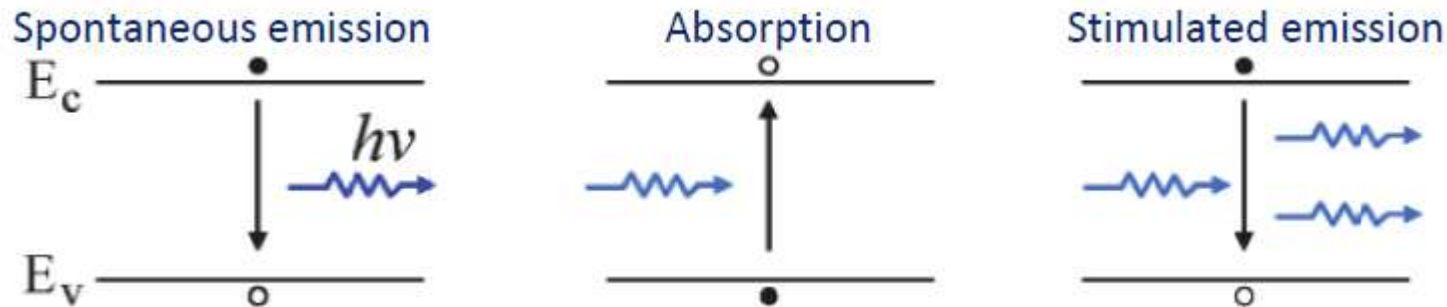

- The emitted photon has energy: $E_g = h\nu = \frac{hc}{\lambda} = \frac{1.24}{\lambda(\mu m)} \text{ eV}$
 - E_g is the bandgap energy
- Non-radiative recombination
 - Reduces the number of electron-hole pairs
 - a) Material defects
 - b) Auger recombination
 - Energy given to another electron (as kinetic energy)

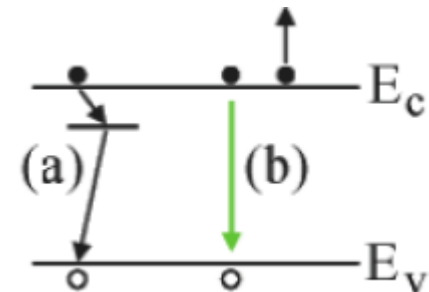

Optical Transmitter

Energy-Bands

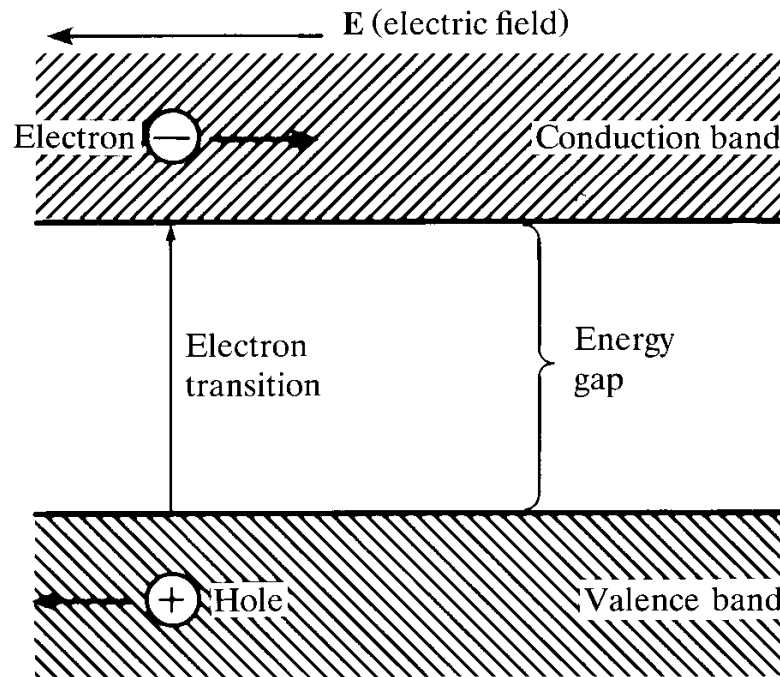

(a)

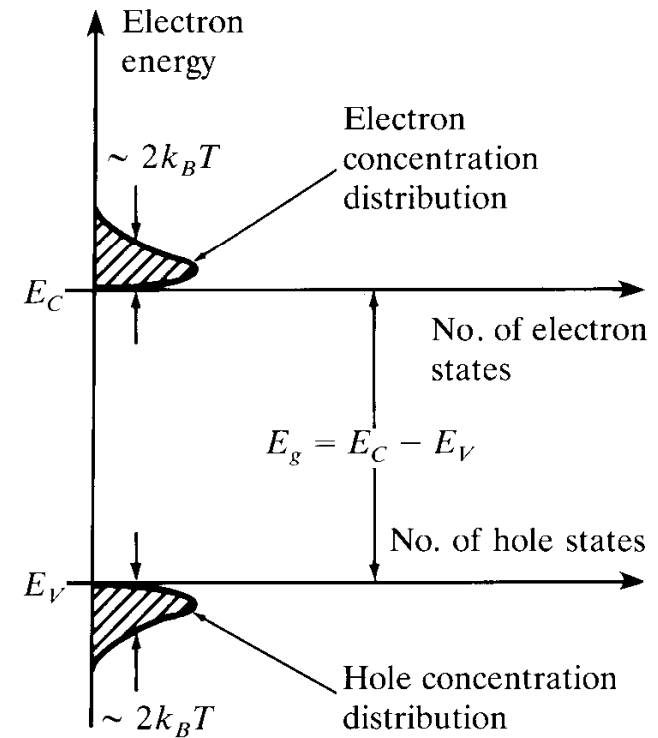

(b)

- Pure Group. IV (intrinsic semiconductor) material has equal number of holes and electrons.
- Thermal excitation of an electron from the valence band to the conduction band enable it to freely move.

Optical Transmitter

n-type material

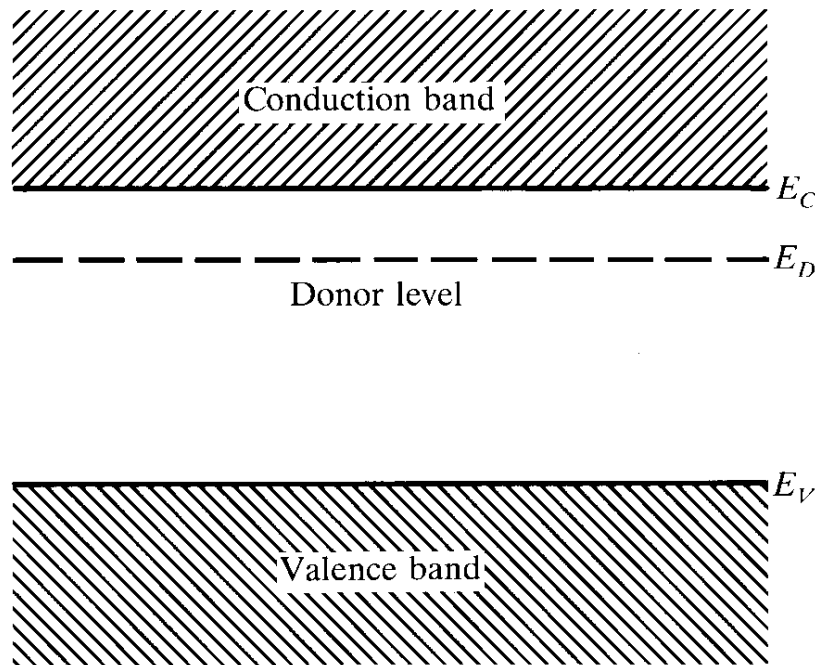

(a)

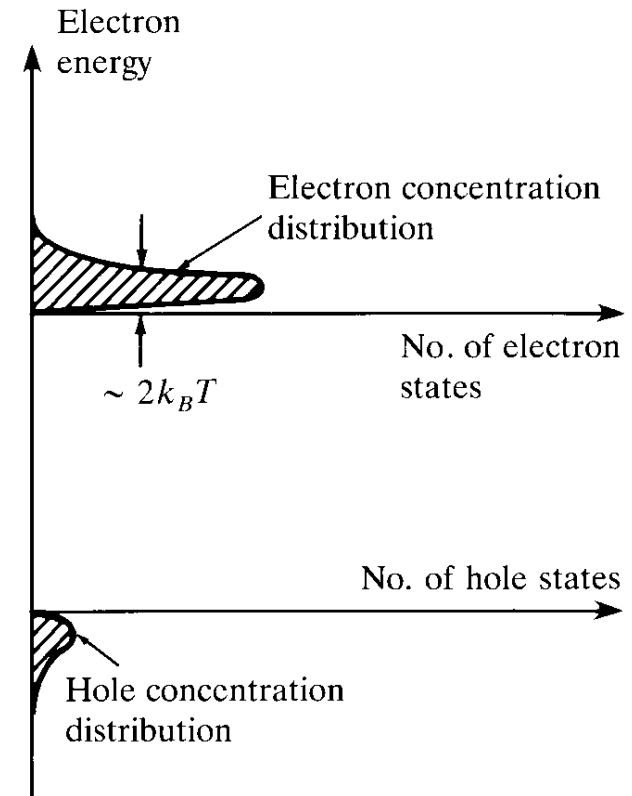

(b)

- Donor level in an n-type (Group V) semiconductor.
- The ionization of donor impurities creates an increased electron concentration distribution.

Optical Transmitter

p-type material

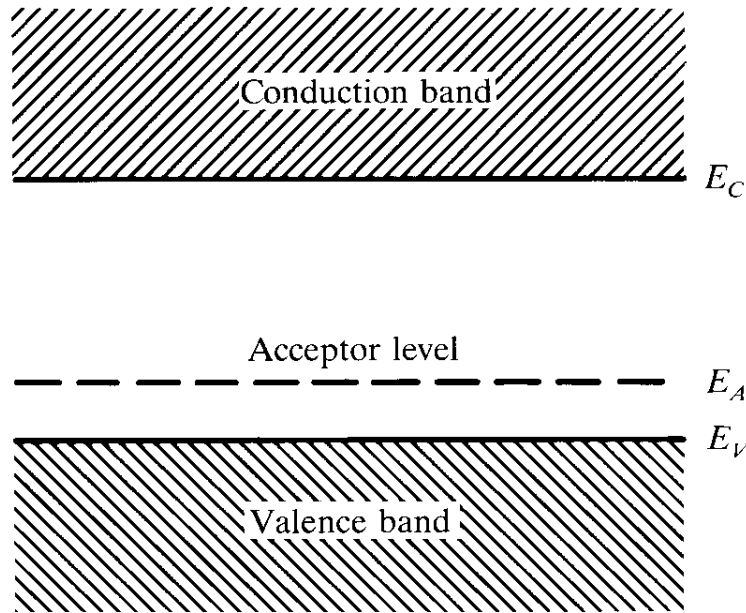

(a)

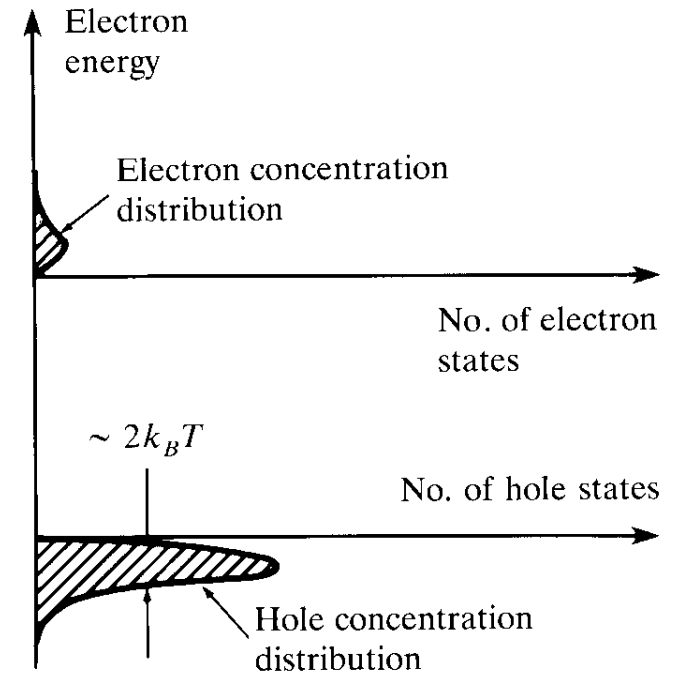

(b)

- Acceptor level in an p-type (Group III) semiconductor.
- The ionization of acceptor impurities creates an increased hole concentration distribution

Optical Transmitter

Intrinsic & Extrinsic Materials

Intrinsic material: A pure material with no impurities

$$n = p = n_i \sim \exp\left(-\frac{E_g}{2k_B T}\right)$$

n, p, n_i = the electron, hole, intrinsic concentrations

E_g = the gap energy ; T = temperature

Extrinsic material: donor or acceptor type semiconductors:

$$pn = n_i^2$$

- **Majority carriers**: electrons in n-type or holes in p-type.
- **Minority carriers**: holes in n-type or electrons in p-type.
- The operation of semiconductor devices is essentially based on the injection and extraction of minority carriers.

Optical Transmitter

Indirect Band Gap Semiconductors

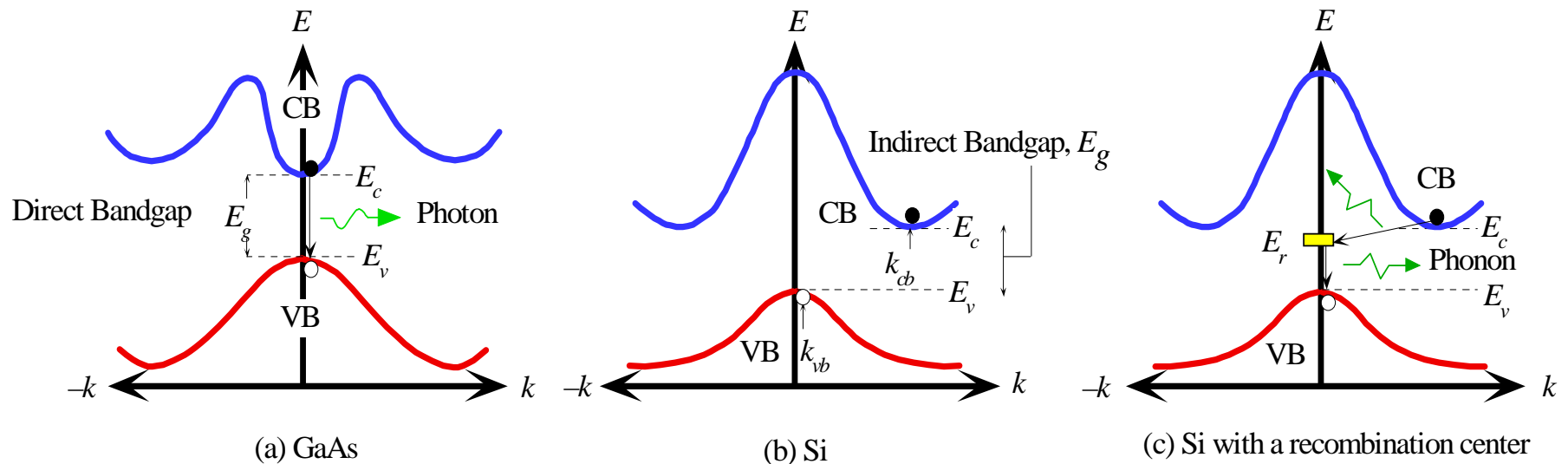

(a) In GaAs the minimum of the CB is directly above the maximum of the VB. GaAs is therefore a direct bandgap semiconductor. (b) In Si, the minimum of the CB is displaced from the maximum of the VB and Si is an indirect bandgap semiconductor. (c) Recombination of an electron and a hole in Si involves a recombination center .

© 1999 S.O. Kasap *Optoelectronics* (Prentice Hall)

Direct-bandgap materials (often III-V semiconductors) ensure high quantum efficiency

Semiconductor Physics

LEDs and laser diodes consist of a [pn junction](#) constructed of direct-bandgap III-V materials.

When the *pn* junction is **forward biased**, electrons and holes are injected into the *p* and *n* regions, respectively.

The injected minority carriers recombine either,

1. [radiatively](#) (a photon of energy $E = h\nu$ is emitted) or
2. [nonradiatively](#) (heat is emitted).

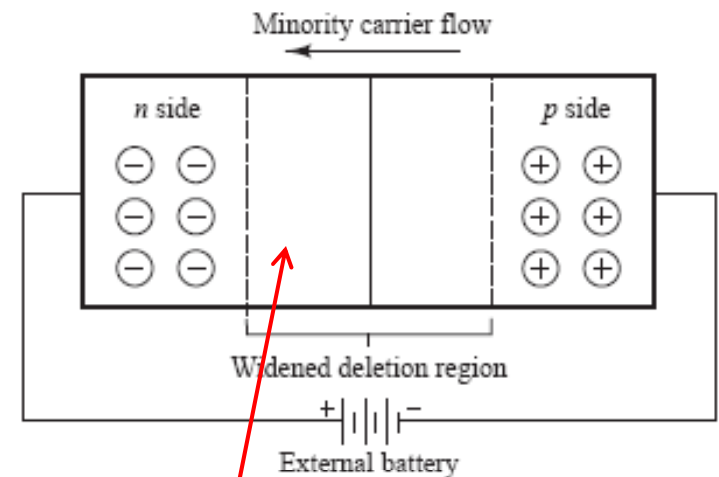

Fig. 4.5 *A reverse bias widens the depletion region but allows minority carriers to move freely with the applied field.*

The ***pn junction*** is known as the [active](#) or [recombination region](#).

Optical Transmitter

Wavelength Bands and Materials

Band	Description	Wavelength range
O band	original	1260–1360 nm
E band	extended	1360–1460 nm
S band	short wavelengths	1460–1530 nm
C band	conventional ("erbium window")	1530–1565 nm
L band	long wavelengths	1565–1625 nm
U band	ultralong wavelengths	1625–1675 nm

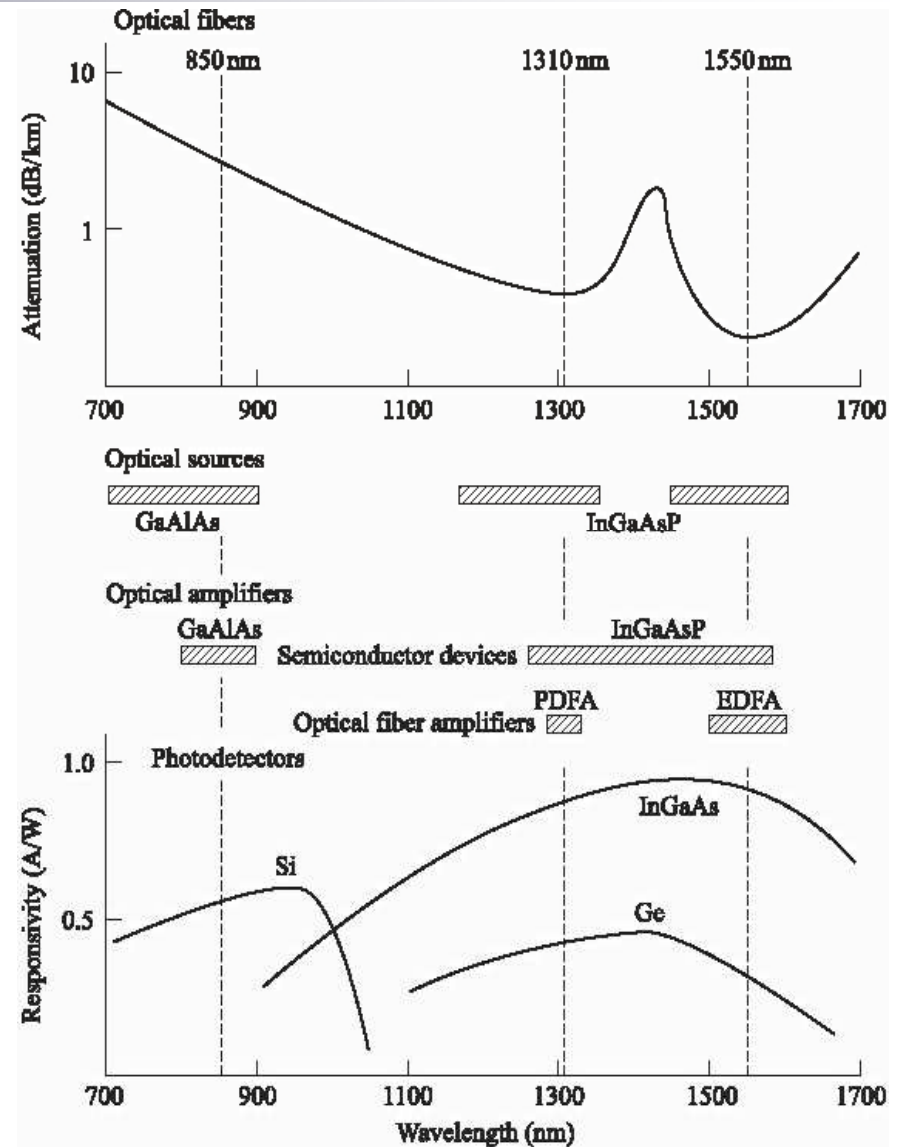

Physical Design of an LED

- *An LED emits incoherent, non-directional, and unpolarized **spontaneous** photons.*
- *An LED does not have a threshold current.*
- ***Double hetero structure** (2 *p* type and 2 *n* type materials) is used to improve light output*
- *Each region shall also have the right **refractive index** to guide the light (optical property)*
- *Light exits via the surface (SLED) or the edge (ELED)*

Optical Transmitter

Double-Heterostructure configuration

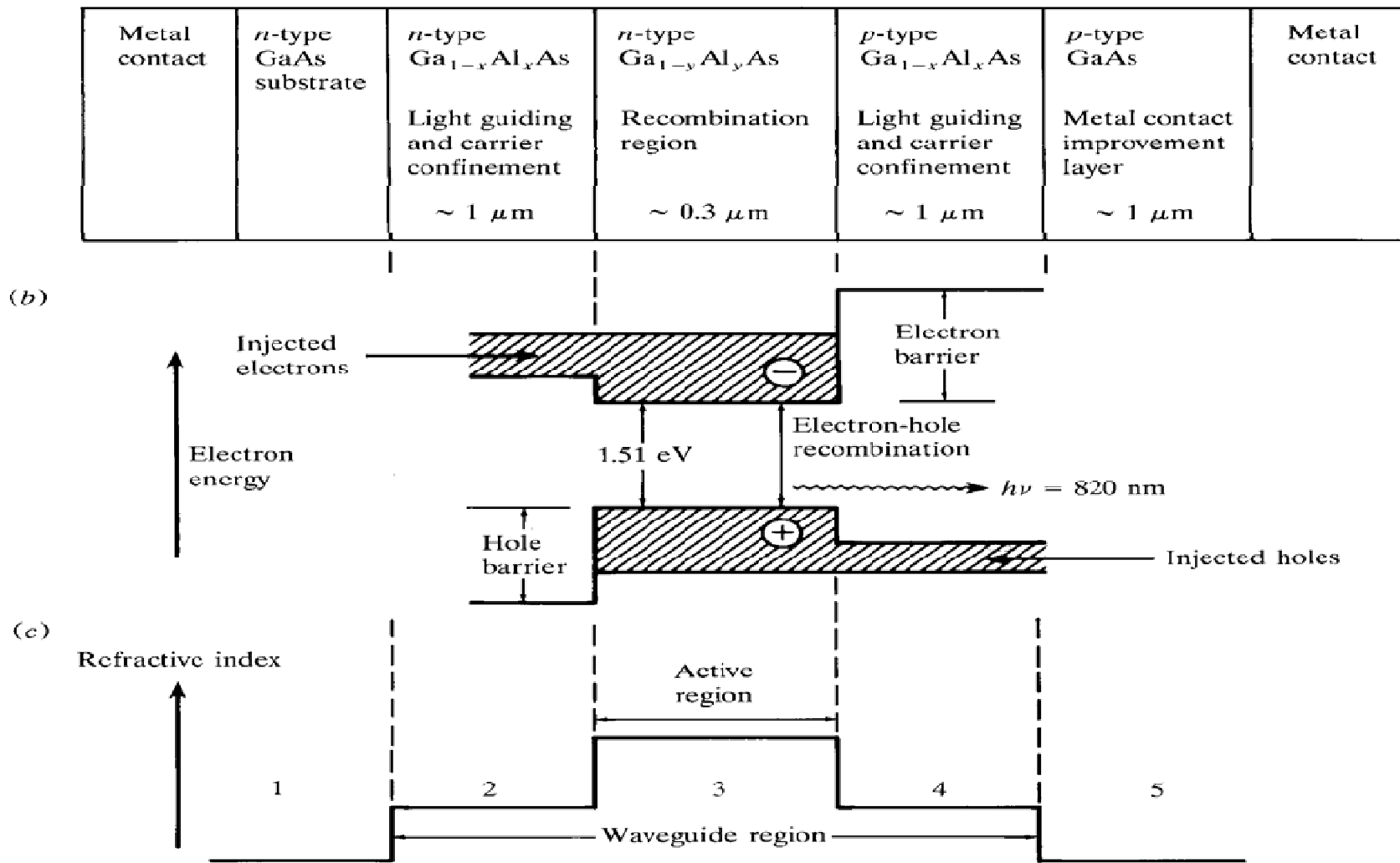

Optical Transmitter

Light-Emitting Diodes (LED)

LED features:

- ❑ Made of GaAlAs (850 nm) or InGaAsP (S-L bands)
- ❑ Broad spectral output (50 to 150 nm)
- ❑ Optical output powers less than -13 dBm (50 μ W)
- ❑ Can be modulated only up a few hundred Mb/s
- ❑ Less expensive than laser diodes
- ❑ Edge-emitter or surface emitter structures

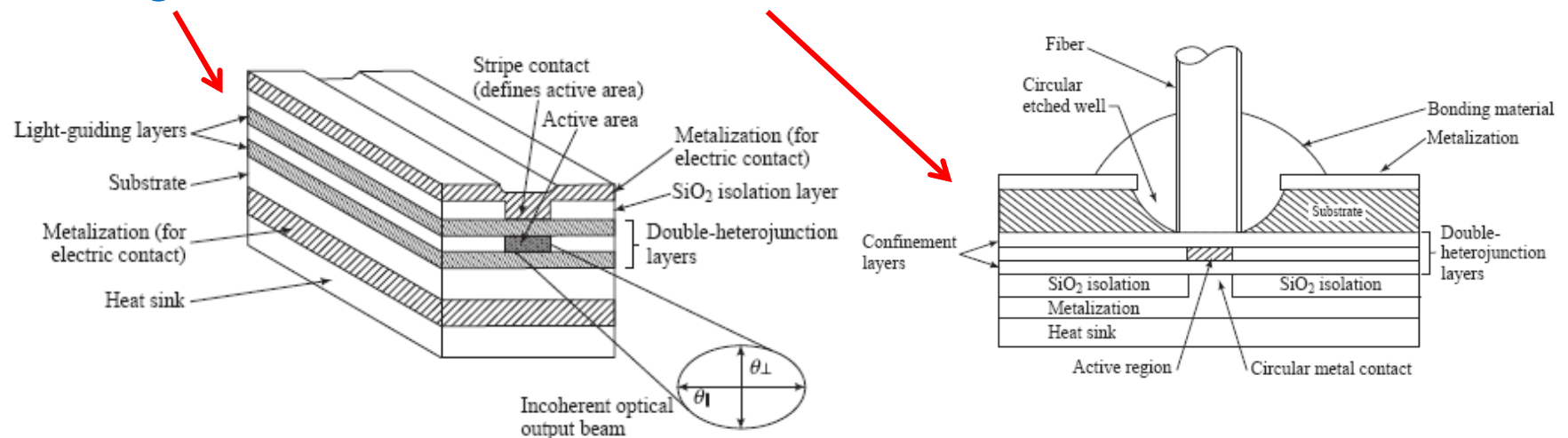

Optical Transmitter

Ratio between Semiconductors

Relationship between the crystal lattice spacing, E_g , emission λ at room temperature.

The shaded area is for the quaternary alloy $In_{1-x}Ga_xAs_yP_{1-y}$:

$$E_g = 1.35 - 0.72y + 0.12y^2$$
$$y = 2.2 \cdot x \quad \text{with } 0 \leq x \leq 0.47$$

Bandgap wavelengths from 920 to 1650 nm are covered by this material system.

For $Ga_{1-x}Al_xAs$

$$E_g = 1.424 + 1.266x + 0.266x^2$$

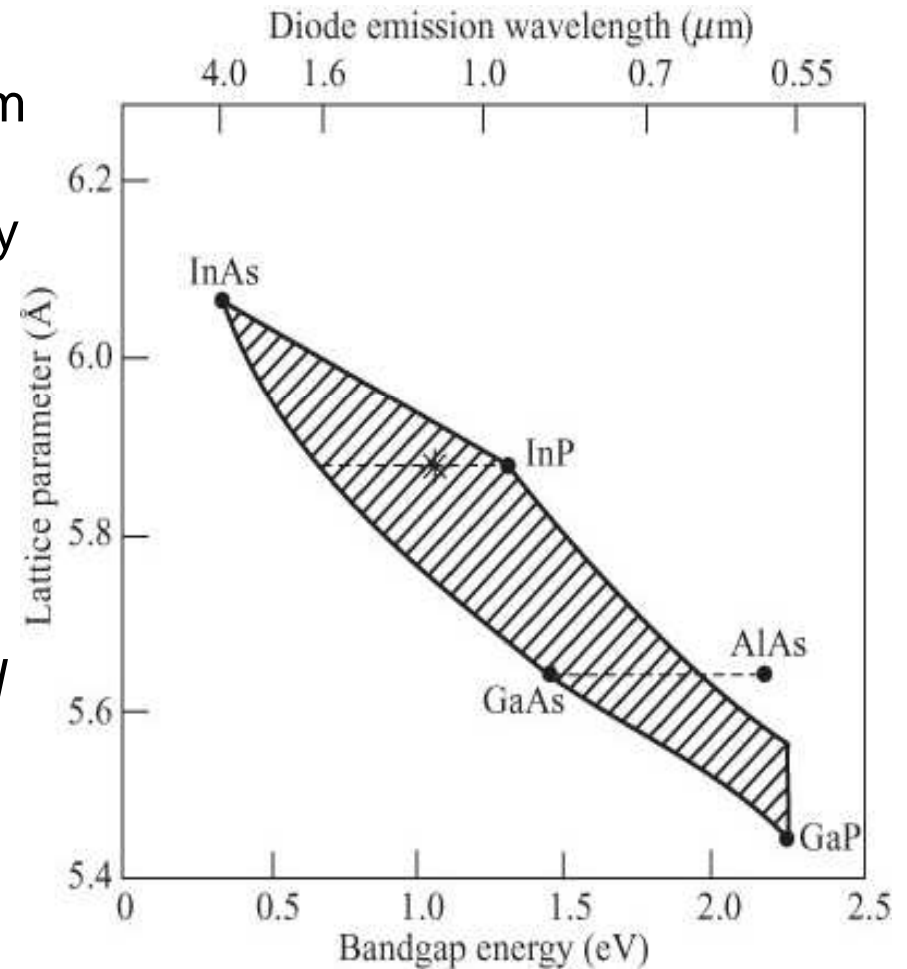

Optical Transmitter

Bandgap Energy

The source emission wavelength depends on the bandgap energy of the device material.

Table 4.1 Bandgap energies of some common semiconductor materials

Semiconductor material	Bandgap energy (eV)
Silicon (Si)	1.12
GaAs	1.43
Germanium (Ge)	0.67
InP	1.35
Ga _{0.93} Al _{0.03} As	1.51

Example 4.3 A particular Ga_{1-x}Al_xAs laser is constructed with a material ratio $x = 0.07$. Find (a) the bandgap of this material; (b) the peak emission wavelength.

Solution: (a) From Eq. (4.4), we have $E_g = 1.424 + 1.266(0.07) + 0.66(0.07)^2 = 1.51$ eV

(b) Using this value of the bandgap energy in Eq. (4.3) yields (in micrometers)

$$\lambda(\mu\text{m}) = 1.240/1.51 = 0.82 \mu\text{m} = 820 \text{ nm}$$

Optical Transmitter

Surface and Edge Emitting LEDs

Typical characteristics of surface and edge emitting LEDs

<i>LED type</i>	<i>Material</i>	<i>Wavelength (nm)</i>	<i>Operating current (mA)</i>	<i>Fiber-coupled power (μW)</i>	<i>Nominal FWHM (nm)</i>
SLED	GaAlAs	850	110	40	35
ELED	InGaAsP	1310	100	15	80
SLED	InGaAsP	1310	110	30	150

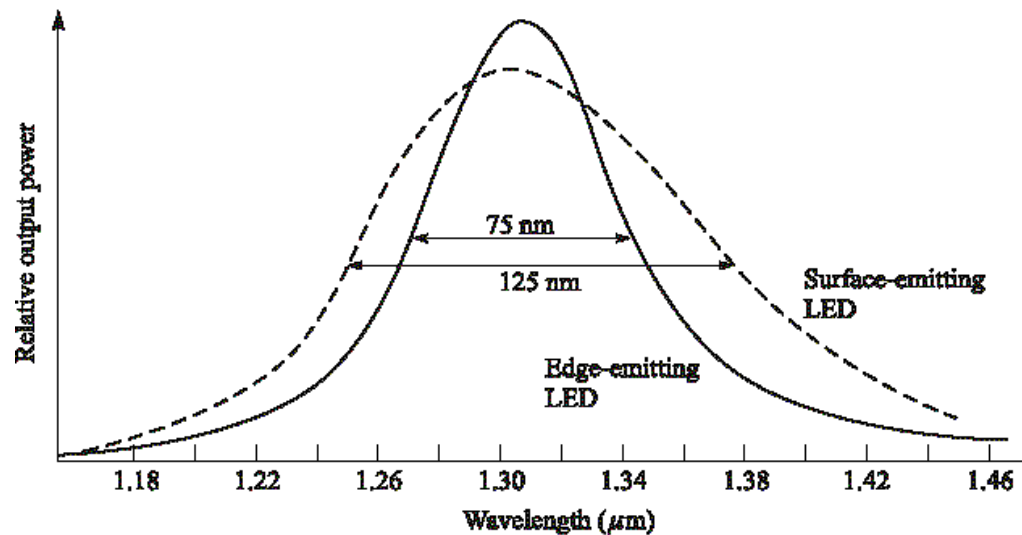

Generally an LED is a broadband light source

Optical Transmitter

Rate equations and Quantum Efficiency of LEDs

When there is no external carrier injection, the excess density decays exponentially due to electron-hole recombination.

$$n(t) = n_0 e^{-t/\tau}$$

n is the excess carrier density,

n_0 = initial injected excess electron density

τ = carrier lifetime

Bulk recombination rate R : $R = -\frac{dn}{dt} = \frac{n}{\tau}$

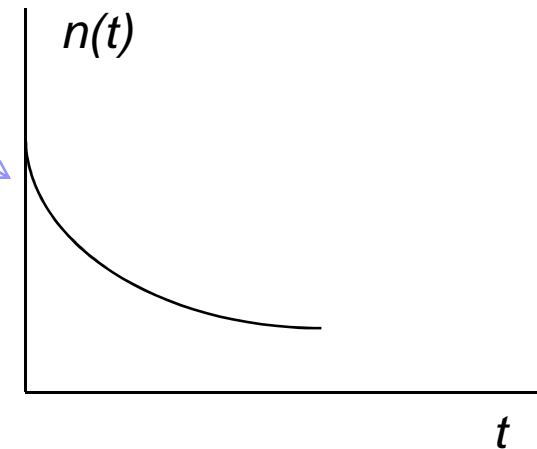

With an external supplied current density of J the rate equation for the electron-hole recombination is:

$$\frac{dn(t)}{dt} = \frac{J}{qd} - \frac{n}{\tau} \quad \text{in equilibrium condition: } \frac{dn(t)}{dt} = 0 \Rightarrow n = \frac{J\tau}{qd}$$

Optical Transmitter

Rate equations and Quantum Efficiency of LEDs

Bulk recombination rate (R) = Radiative recombination rate (R_r)
+ Nonradiative recombination rate (R_{nr})

For exponential decay of excess carriers: Radiative recombination

lifetime : $\tau_r = n/R_r$

Nonradiative recombination

lifetime : $\tau_{nr} = n/R_{nr}$

$$R = R_r + R_{nr} = 1/\tau = 1/\tau_r + 1/\tau_{nr}$$

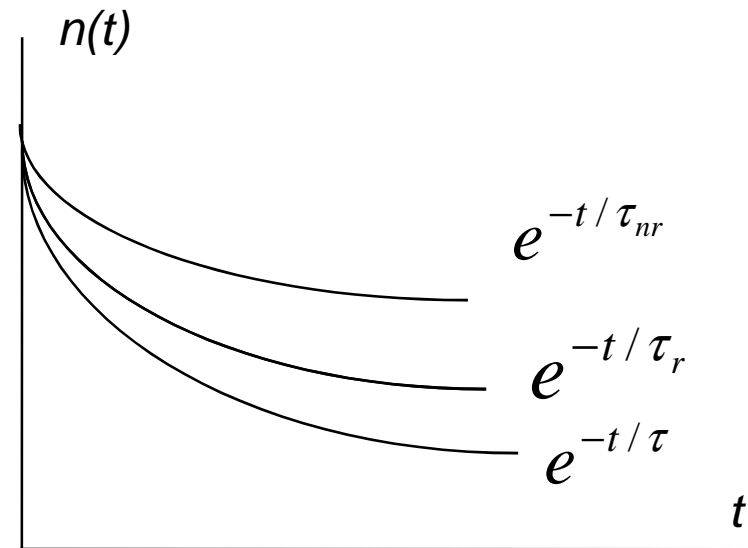

For high quantum efficiency, $R_r \gg R_{nr} \rightarrow \tau_r \ll \tau_{nr}$

Optical Transmitter

Quantum Efficiency

Internal quantum efficiency is the ratio between the radiative recombination rate and the sum of radiative and nonradiative recombination rates

$$\eta_{\text{int}} = \frac{R_r}{R_r + R_{nr}} = \frac{\tau_{nr}}{\tau_r + \tau_{nr}} = \frac{\tau}{\tau_r}$$

$$R_r = \eta_{\text{int}} (R_r + R_{nr}) = I/q$$

Where, the current injected into the LED is I , and q is the charge of an electron.

- Lifetime examples

Material	R_r (cm ³ /s)	τ_r	τ_{nr}	τ	η_{int}
Si	10^{-15}	10 ms	100 ns	100 ns	10^{-5}
GaAs	10^{-10}	100 ns	100 ns	50 ns	0.5

Optical Transmitter

Internal Quantum Efficiency & Optical Power

Optical power generated internally in the active region in the LED is equal to the number of photons/seconds (I/q) times energy per photons ($h\nu$) times the internal quantum efficiency

$$P_{\text{int}} = \eta_{\text{int}} \frac{I}{q} h\nu = \eta_{\text{int}} \frac{hcI}{q\lambda} = 1.24\eta_{\text{int}} \frac{I}{\lambda}$$

P_{int} : Internal optical power,

I : Injected current to active region

Si is an indirect bandgap material resulting in a small internal quantum efficiency.

The radiative transitions are sufficiently fast in GaAs, (direct bandgap), and the internal quantum efficiency is large.

Optical Transmitter

External Efficiency

Only a small portion of internally generated the light exits the LED due to:

- Absorption losses $\propto \exp(-\alpha l)$, where α is the absorption coefficient and l is the path length
- Fresnel reflection losses, that increases with the angle of incidence
- Loss due to total internal reflection (TIR) which results in a small '*escape cone*'

$$\eta_{\text{ext}} = \frac{\text{\# of photons emitted from LED}}{\text{\# of internally generated photons}}$$

Optical Transmitter

Fresnel Reflection

Whenever light travels from a medium of refractive index n_1 to a medium of index n_2 , then Fresnel reflection will happen. For perpendicular incidence the *Fresnel reflect.* is given by,

$$R = \left(\frac{n_1 - n_2}{n_1 + n_2} \right)^2 \quad T = \frac{4n_1 n_2}{(n_1 + n_2)^2}$$

- R is the **Fresnel reflectivity** at the fiber-core end face;
- T is the **Fresnel transmissivity** (Note **$R+T = 1$**)

Note: When the amplitudes of the light is considered, the reflection coefficient $r = (n_1 - n_2)/(n_1 + n_2)$ relates the incident and reflected wave.

In general at the surface of any two material with n_1 and n_2 ref indices, there will be Fresnel Loss: **Loss_{Fres} = -10 · Log (T)**

Optical Transmitter

Escape cone

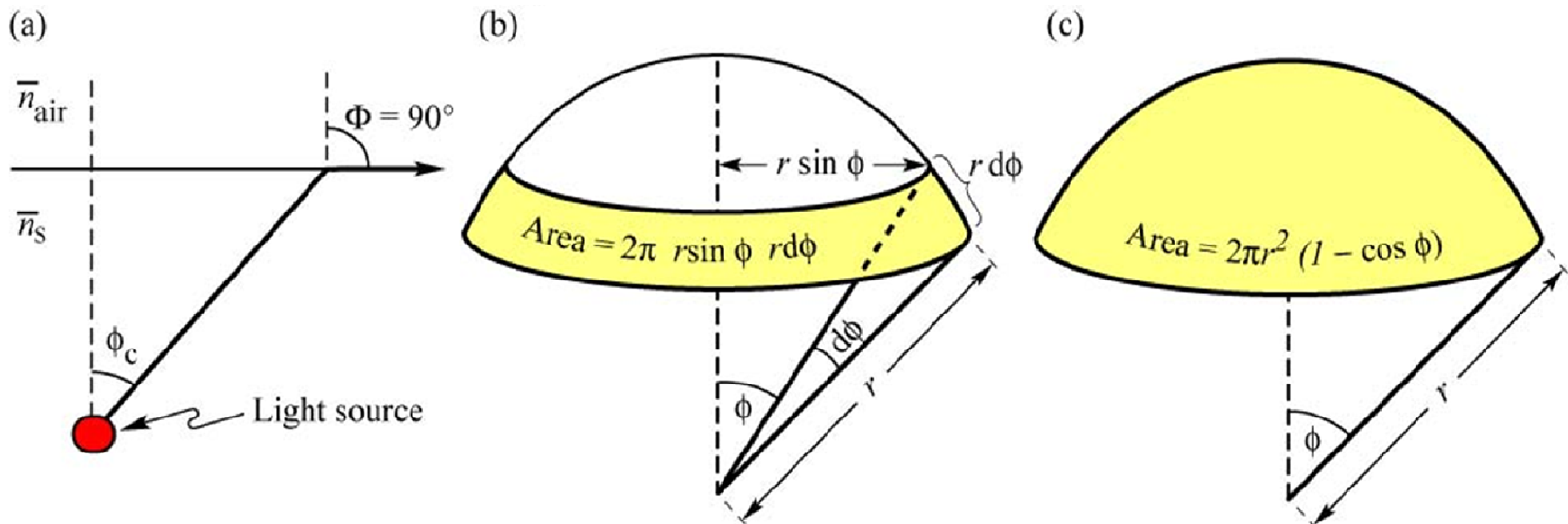

Fig. 5.3. (a) Definition of the escape cone by the critical angle ϕ_c . (b) Area element dA . (c) Area of calotte-shaped section of the sphere defined by radius r and angle ϕ_c .

The fraction of light lies within the escape cone from a point source

$$\frac{\text{Area}}{4\pi r^2} = \frac{1 - \cos(\phi_c)}{2} \approx \frac{1}{4n^2}$$

Optical Transmitter

Half Power Beam Width ($\theta_{1/2}$)

The angle at which the power is half of its peak value

$$B(\theta_{1/2}) = B_o/2$$

$$B(\theta) = B_o \cdot \cos^L(\theta)$$

- for Lambertian source ($L=1$)

$$\theta_{1/2} = 60^\circ$$

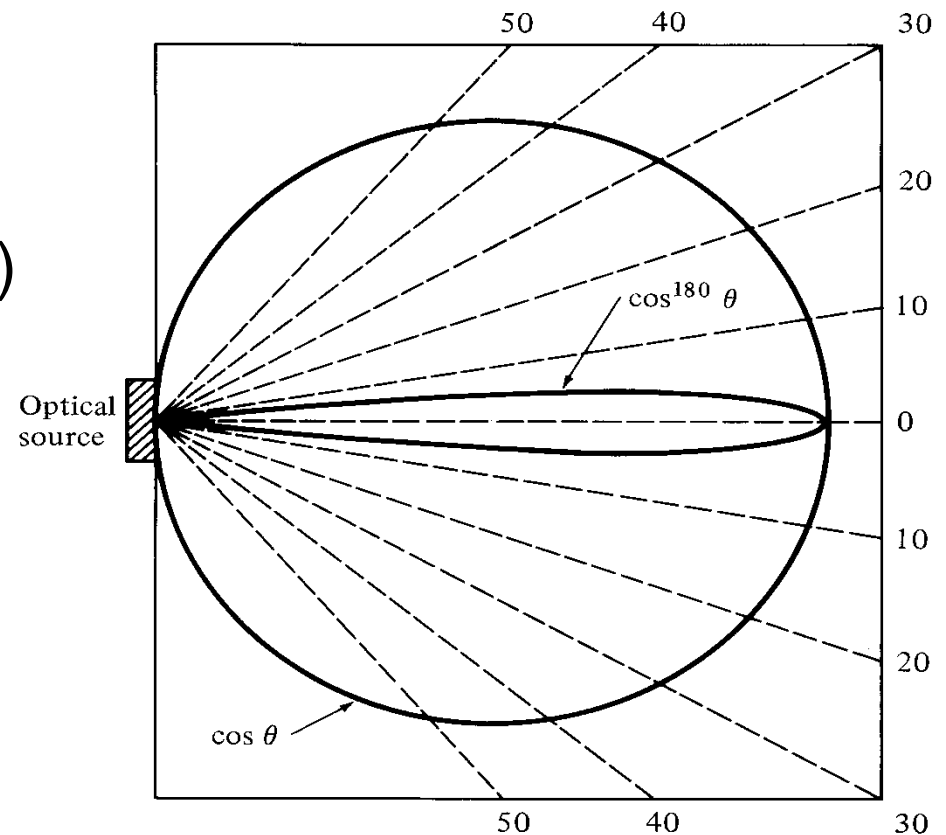

Optical Transmitter

Source-to-Fiber Power Launching

Assume a surface-emitting LED of radius r_s less than the fiber-core radius a . The total optical power P_s emitted from the source of area A_s into a hemisphere ($2\pi r_s$) is given by

$$P_s = A_s \int_0^{2\pi} \left(\int_0^{\pi/2} B(\theta, \phi) d\theta \right) d\phi$$

$$= \pi r_s^2 2\pi B_o \int_0^{\pi/2} \cos(\theta) \sin(\theta) d\theta = \pi^2 r_s^2 B_o$$

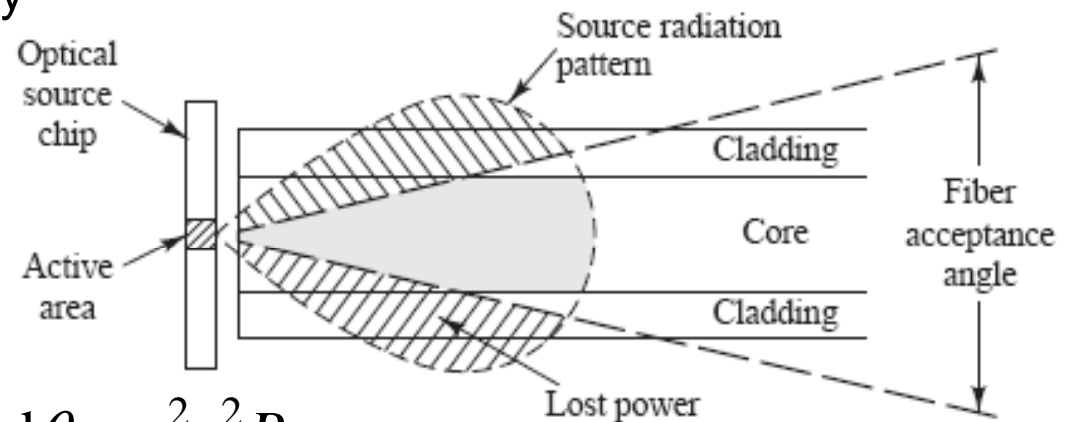

In terms of P_s the optical power coupled into a step-index fiber from the LED is:

$$P_{LED,step} = \begin{cases} P_s \cdot (NA)^2 & \text{for } r_s \leq a \\ (a/r_s)^2 P_s \cdot (NA)^2 & \text{for } r_s > a \end{cases}$$

Optical Transmitter

Source-to-Fiber Power Coupling

Comparison of the optical powers coupled into two step-index fibers

Example 5.2 Consider an LED that has a circular emitting area of radius $35 \mu\text{m}$ and a lambertian emission pattern with $150 \text{ W}/(\text{cm}^2 \cdot \text{sr})$ axial radiance at a given drive current. Compare the optical powers coupled into two step-index fibers, one of which has a core radius of $25 \mu\text{m}$ with $\text{NA} = 0.20$ and the other which has a core radius of $50 \mu\text{m}$ with $\text{NA} = 0.20$.

Solution: For the larger core fiber, we use Eqs (5.6) and (5.7) to get

$$\begin{aligned} P_{\text{LED, step}} &= P_s (\text{NA})^2 = \pi^2 r_s^2 B_0 (\text{NA})^2 \\ &= \pi^2 (0.0035 \text{ cm})^2 [150 \text{ W}/(\text{cm}^2 \cdot \text{sr})] (0.20)^2 \\ &= 0.725 \text{ mW} \end{aligned}$$

For the case when the fiber end-face area is smaller than the emitting surface area, we use Eq. (5.8). Thus the coupled power is less than the above case by the ratio of the radii squared:

$$\begin{aligned} P_{\text{LED, step}} &= \left(\frac{25 \mu\text{m}}{35 \mu\text{m}} \right)^2 P_s (\text{NA})^2 \\ &= \left(\frac{25 \mu\text{m}}{35 \mu\text{m}} \right)^2 (0.725 \text{ mW}) \\ &= 0.37 \text{ mW} \end{aligned}$$

Optical Transmitter

Modulation of an LED

- The LED output power is:
 - η_{ext} is external quantum efficiency
 - Fraction of photons that escape the device, ~1–5%
 - η_{int} is internal quantum efficiency
 - Fraction of carriers that recombine radiatively, ~50%
 - I is injected current
- The response time of an optical source determines how fast an electrical input drive signal can vary the light output level;
- If the drive current is modulated at a frequency ω and P_0 is the power emitted at zero modulation frequency, the optical output power of the device will vary as:

$$P_e = \eta_{ext} \eta_{int} \frac{h \cdot \nu}{q} I$$

$$P(\omega) = P_0 \cdot \left[1 + (\omega \tau_i)^2 \right]^{-1/2}$$

Optical Transmitter

Modulation of LED

The frequency response of an LED depends on:

- 1- Doping level in the active region
- 2- Injected carrier lifetime in the recombination region, .
- 3- Parasitic capacitance of the LED

If the drive current of an LED is modulated at a frequency of ω , the output optical power of the device will vary as:

$$BW_{EL} = 10\log\left[\frac{p(\omega)}{p(0)}\right] = 20\log\left[\frac{I(\omega)}{I(0)}\right] \quad BW_{OPT} = 10\log\left[\frac{P(\omega)}{P(0)}\right] = 10\log\left[\frac{I(\omega)}{I(0)}\right]$$

p : electrical power, I : electrical current

Electrical current is directly proportional to the optical power, thus we can define electrical bandwidth and optical bandwidth, separately.

Optical Transmitter

LED modulation response

The rate equation for an LED contains no stimulated emission:

$$\frac{dN(t)}{dt} = \frac{J}{q} - \frac{N}{\tau_c}$$

Assume a sinusoidal modulation: $I(t) = I_b + I_m \exp(j\omega_m t)$

The carrier modulation is obtained:

$$N(t) = \frac{\tau_c J}{q} + \frac{\tau_c I_m}{q} \cdot \frac{1}{1 + j\omega_m \tau_c} \exp(j\omega_m t)$$

We obtain the 3-dB bandwidth $f_{-3dB} = \frac{\sqrt{3}}{2\pi\tau_c}$

- Limited by the carrier lifetime
- Typical value is 50-150MHz

The spectrum wide for a 1.3 μm InGaAs LED is $\sim 50\text{-}60\text{nm}$
Only suitable for short distance communication.

Optical Transmitter

-3dB electrical & optical bandwidths

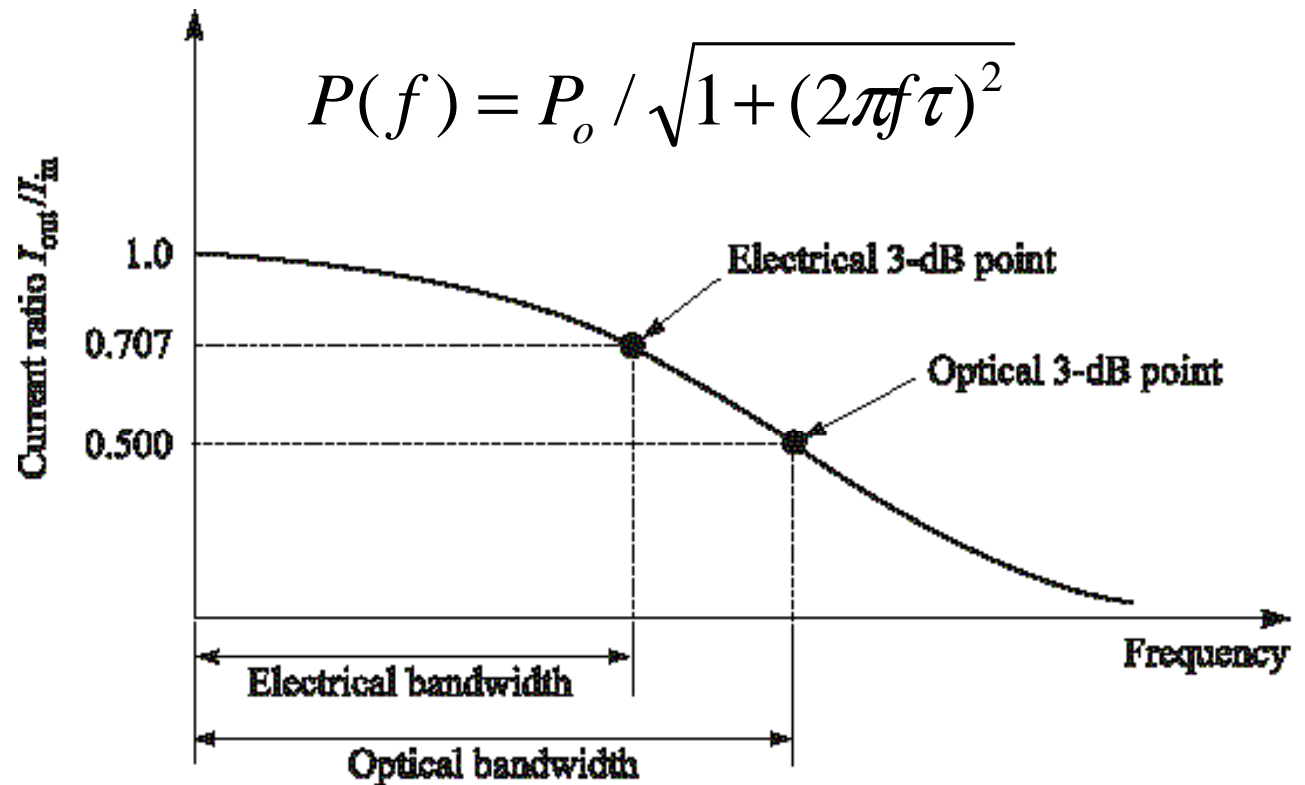

Optical Power $\sim I(f)$; Electrical Power $\sim I^2(f)$

Electrical attenuation = 2 x Optical attenuation

Optical Transmitter

Lenses for Coupling Improvement

If the source emitting area is smaller than the core area, a miniature lens can improve the power-coupling efficiency

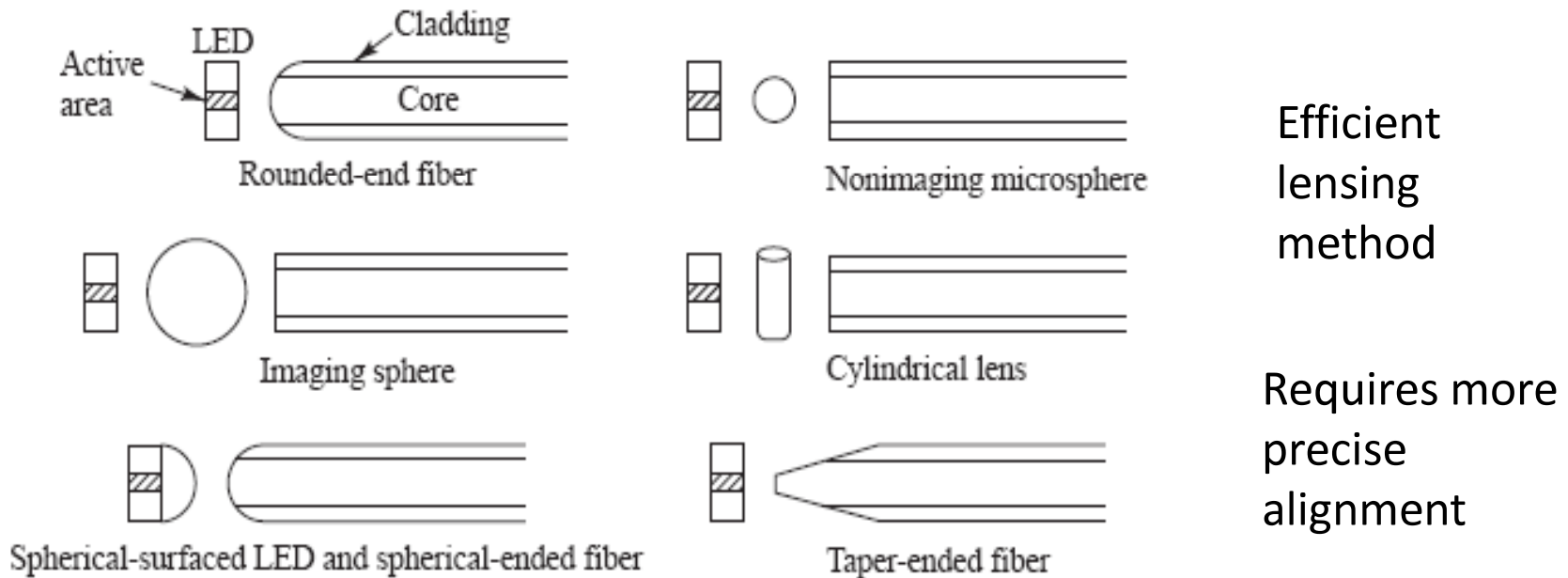

Examples of possible lensing schemes used to improve optical source-to-fiber coupling efficiency

Optical Transmitter

Fiber-to-Fiber Joints

Different modal distributions of the optical beam emerging from a fiber result in different degrees of coupling loss

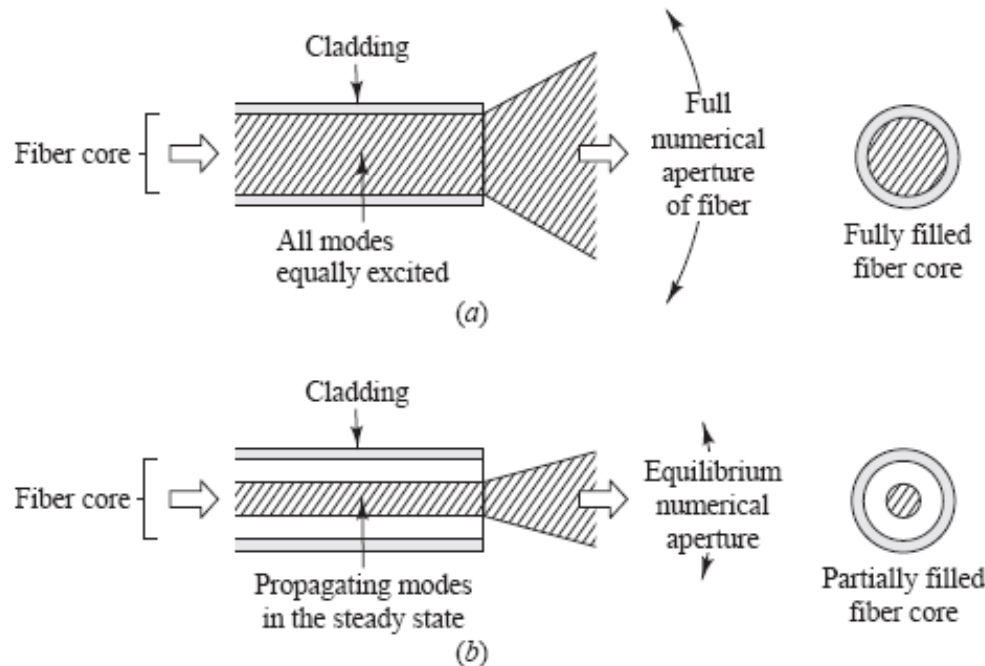

All modes in the emitting fiber are equally excited. Achieving a steady-state in the receiving fiber results in an additional loss.

A steady-state modal equilibrium has been established in the emitting fiber.

Optical Transmitter

Mechanical Misalignment

For a receiving fiber to accept all the optical power emitted by the first fiber, there must be perfect mechanical alignment between the two fibers, and their geometric and waveguide characteristics must match precisely.

Mechanical alignment is a major problem in joining fibers

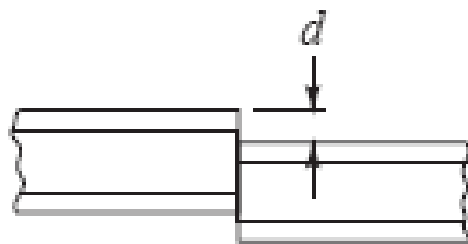

(a) Lateral (axial)

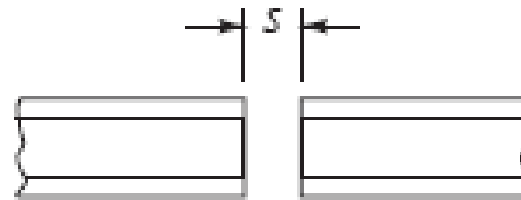

(b) Longitudinal (end separation)

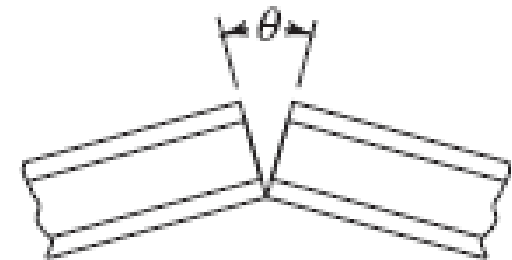

(c) Angular

Optical Transmitter

Axial Displacement

Axial or lateral displacement results when the axes of the two fibers are separated by a distance d .

This misalignment is the most common and has the greatest power loss.

For the step-index fiber, the coupling efficiency is simply the ratio of the common-core area to the core end-face area:

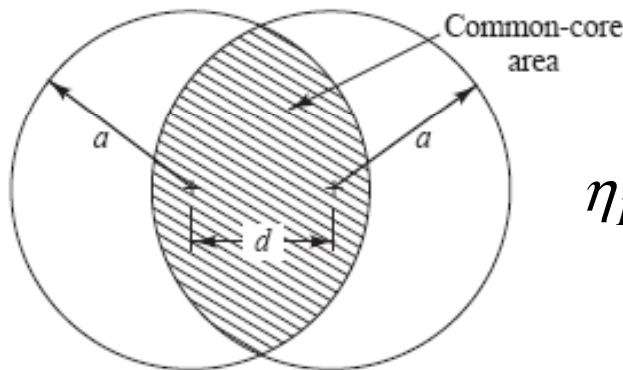

$$\eta_{F,step} = \frac{A_{comm}}{\pi a^2} = \frac{2}{\pi} \arccos \frac{d}{2a} - \frac{d}{\pi a} \sqrt{1 - \left(\frac{d}{2a}\right)^2}$$

Example 5.7 An engineer makes a joint between two identical step-index fibers. Each fiber has a core diameter of $50 \mu\text{m}$. If the two fibers have an axial (lateral) misalignment of $5 \mu\text{m}$, what is the insertion loss at the joint?

Solution: Using Eq. (5.23) we find that the coupling efficiency is

$$\eta_F = \frac{2}{\pi} \cos^{-1} \left(\frac{5}{50} \right) - \frac{5}{\pi(25)} \left[1 - \left(\frac{5}{50} \right)^2 \right]^{1/2} = 0.873$$

From Eq. (5.21) we find that the fiber-to-fiber insertion loss L_F is

$$L_F = -10 \log \eta_F = -10 \log 0.873 = -0.590 \text{ dB}$$

Optical Transmitter

Angular Misalignment

When two fiber ends are separated longitudinally by a gap s , not all the higher-mode optical power emitted in the ring of width x will be intercepted by the receiving fiber.

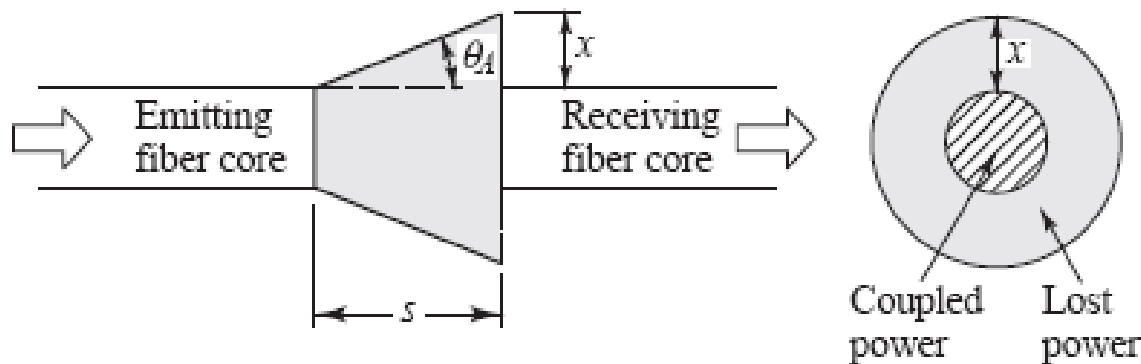

The loss for an offset joint between two identical step-index fibers is

$$L_F = -10\log\left(\frac{a}{a+x}\right) = -10\log\left(\frac{a}{a+s \cdot \tan \theta_A}\right) = 20\log\left(1 + \frac{s}{a \sin\left(\frac{NA}{n}\right)}\right)$$



Optical Transmitter

Optical Fiber Connector Types (1)

<i>Connector type</i>	<i>Features</i>	<i>Applications</i>
ST 	Uses a ceramic ferrule and a rugged metal housing. It is latched in place by twisting. Typical loss range is 0.20–0.50 dB.	Designed for distribution applications using either multimode or single-mode fibers.
SC 	Designed by NTT for snap-in connection in tight spaces. Uses a ceramic ferrule in simplex or duplex plastic housings for either multimode or single-mode fibers. Typical loss range is 0.20–0.45 dB.	Widely used in Gigabit Ethernet, ATM, LAN, MAN, WAN, data communication, Fibre Channel, and telecommunication networks.
LC 	SFF connector that uses a standard RJ-45 telephone plug housing and ceramic ferrules in simplex or duplex plastic housings. Typical loss range is 0.10–0.50 dB.	Available in simplex and duplex configurations for CATV, LAN, MAN, and WAN applications.

Optical Transmitter

Optical Fiber Connector Types (2)

Connector type

Features

Applications

MU



SFF connector based on a 1.25-mm ceramic ferrule and a single free-floating ferrule. Typical loss range is 0.10–0.30 dB.

Used mainly in Japan. Suitable for board-mounted applications and for distribution-cable assemblies.

MT-RJ



SFF connector with two fibers in one molded plastic ferrule and an improved RJ-45 latch mechanism. Typical loss range is 0.25–0.75 dB.

Applications are for MANs and LANs, such as horizontal optical cabling to the desktop.

MPO/MTP



Can house up to twelve multimode or single-mode optical fibers in a single compact ferrule. Typical loss range is 0.25–1.00 dB.

Allows high-density connections between network equipment in telecom rooms.



Optical Transmitter

Optical Fiber Connectors

Principal requirements of a good connectors:

1. *Low coupling losses*. The connector assembly must maintain stringent alignment tolerances to assure low mating losses. These low losses must not change significantly during operation or after numerous connects and disconnects.
2. *Interchangeability*. Connectors of the same type must be compatible from one manufacturer to another.
3. *Ease of assembly*. A technician should be able to install the connector easily in a field environment. The connector loss should also be fairly insensitive to the assembly skill of the technician.
4. *Low environmental sensitivity*. Conditions such as temperature, dust, and moisture should have a small effect on connector-loss variations.
5. *Low cost and reliable construction*. The connector must have a precision suitable to the application, but its cost must not be a major factor in the fiber system.
6. *Ease of connection*. One should be able to mate the connector by hand



Optical Transmitter

Drawbacks of LED

- ❑ Large line width (30-40 nm)
- ❑ Large beam width (Low coupling to the fiber)
- ❑ Low output power
- ❑ Low E/O conversion efficiency

Advantages

- ❑ Robust
- ❑ Linear

A better light source addressing all these issues is Laser.



Optical Transmitter

The LASER

Light Amplification by 'Stimulated Emission' and Radiation

Laser is an optical oscillator. It comprises a resonant optical amplifier whose output is fed back into its input with matching phase. Any oscillator contains:

- 1 - An amplifier (with gain-saturation mechanism)
- 2 - A positive feedback system
- 3 - A frequency selection mechanism
- 4 - An output coupling scheme

Fundamental Lasing Operation:

Absorption: An atom in the ground state might absorb a photon emitted by another atom, thus making a transition to an excited state.

Spontaneous Emission: random emission of a photon, which enables the atom to relax to the ground state.

Stimulated Emission: An atom in an excited state might be stimulated to emit a photon by another incident photon.

Optical Transmitter

Spontaneous & Stimulated Emissions

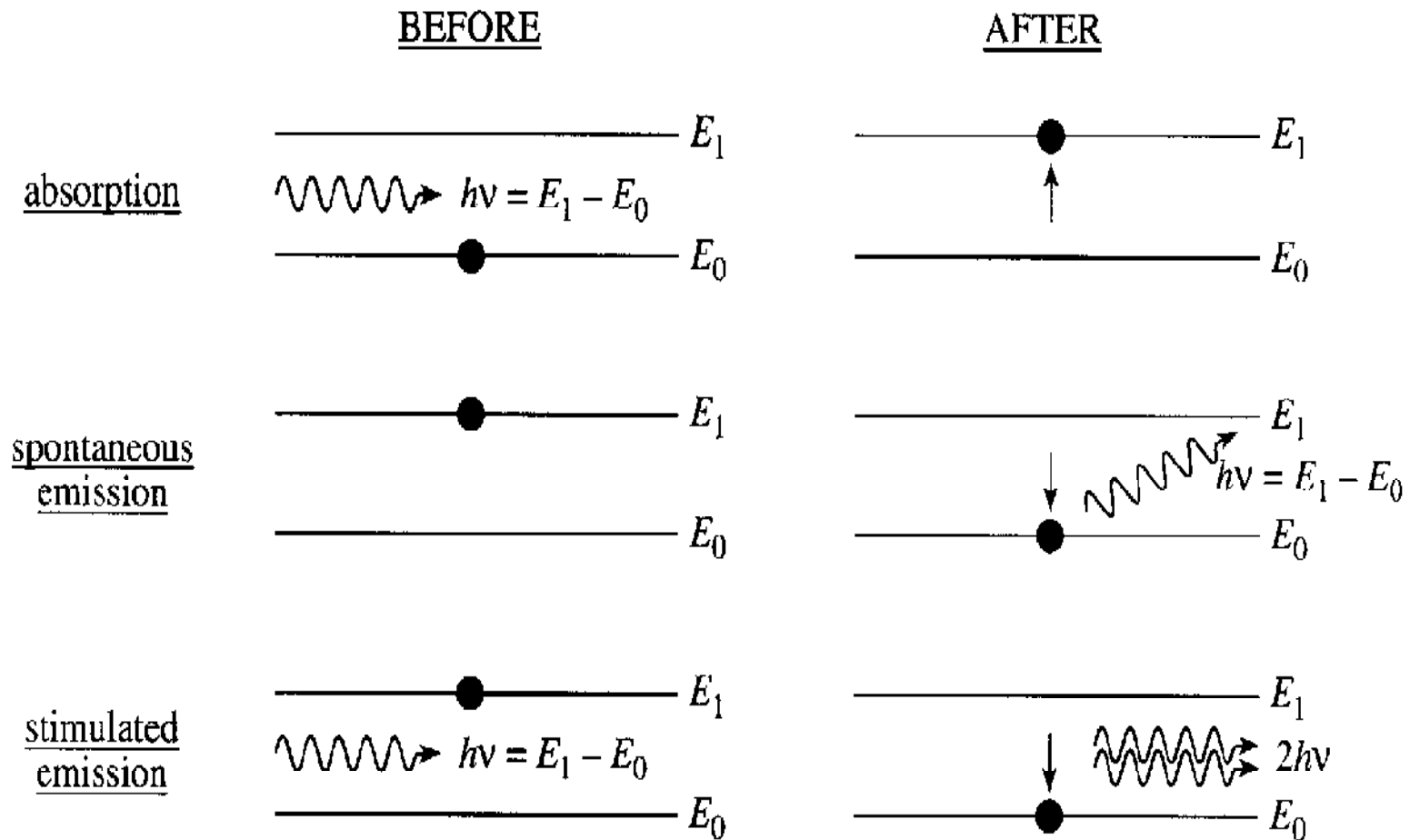

Optical Transmitter

How a Laser Works

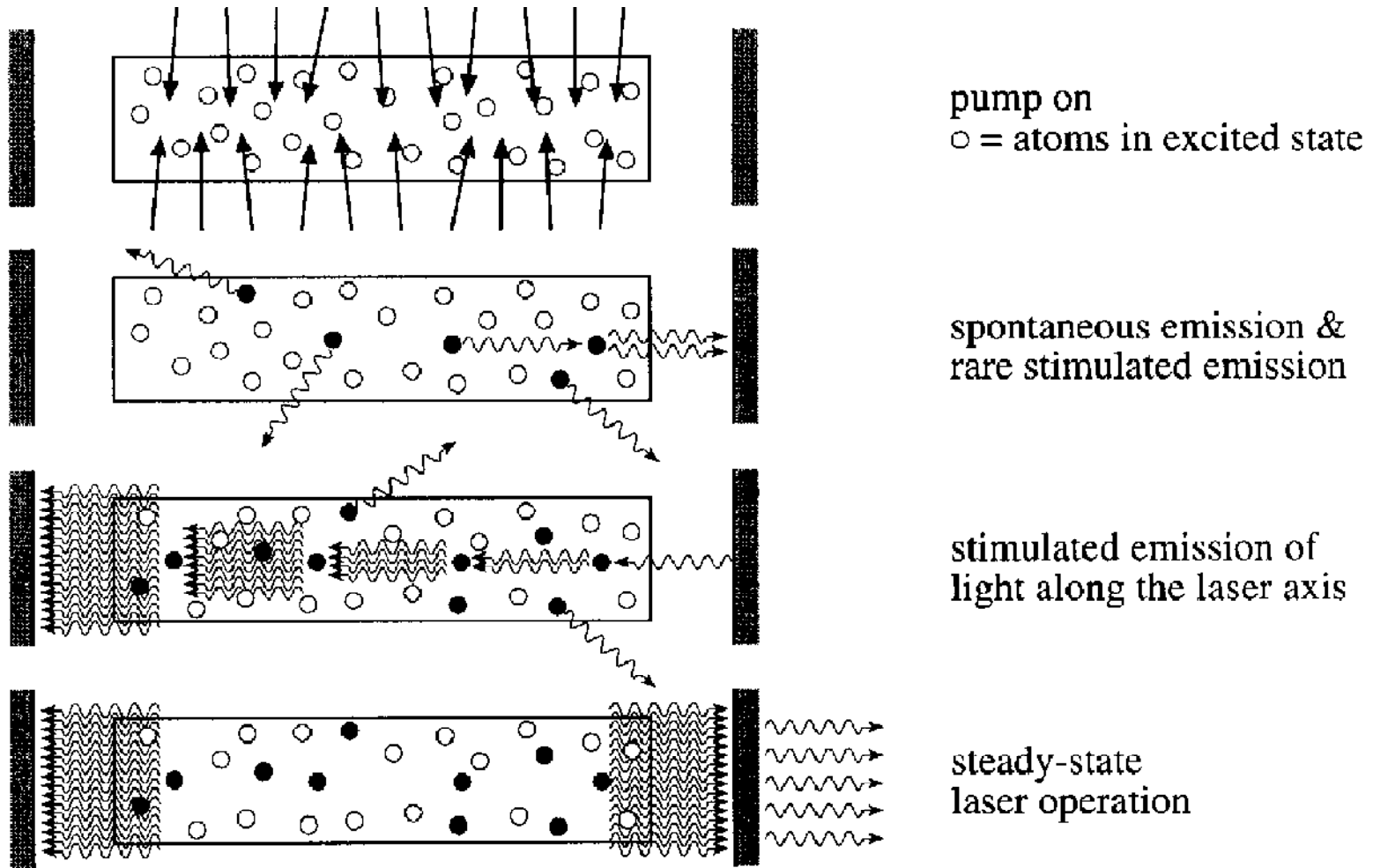

Optical Transmitter

Semiconductor lasers

- Semiconductor lasers use stimulated emission:
 - Coherent light (narrow spectrum, less pulse broadening in fibers)
 - High output power (> 10 mW)
 - Narrow beam width, high coupling efficiency (30–70%)
 - High modulation bandwidth (up to ≈ 25 GHz)

▪ Principle: A gain medium with feedback (Fabry- Perot cavity)

- Reduces nr of electron-hole pairs

▪ Optical gain requires population inversion

- Cannot occur in thermal equilibrium

- The gain has a nearly linear dependence on N above N_t
 - N is the injected carrier density
 - N_t is the transparency density value

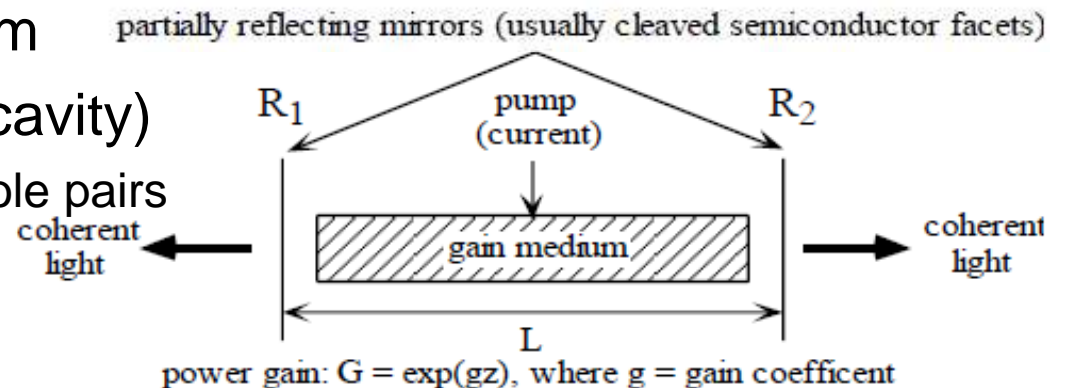

Optical Transmitter

The heterostructure junction

- In a heterostructure junction
 - Stimulated emission occurs where the bandgap is lower
 - Gain is increased by the increasing carrier density
 - Light is confined to the region where the index of refraction is higher
- Direct bandgap is required
 - AlGaAs,
 $\lambda = 0.81\text{--}0.87\ \mu\text{m}$
 - InGaAsP
 $\lambda = 1\text{--}1.65\ \mu\text{m}$
 - Si is not used

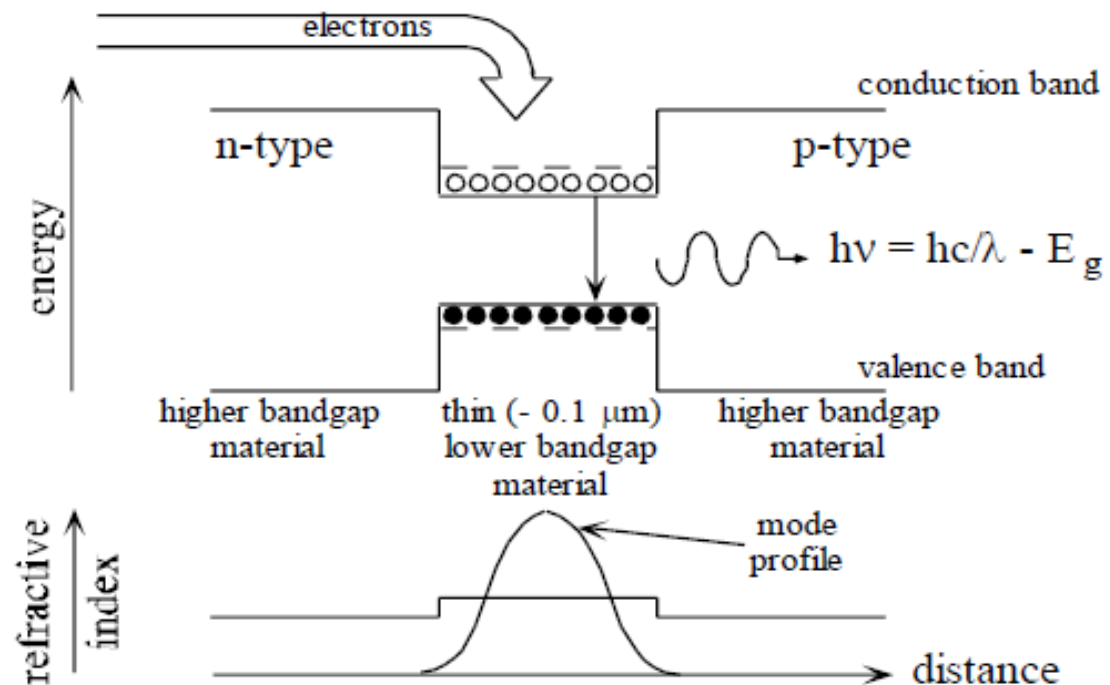

Optical Transmitter

Lasing conditions

The power reflectivity R of an air-semiconductor interface is
(Usually $R_1 = R_2 = R$)

$$R = \left(\frac{n_1 - n_2}{n_1 + n_2} \right)^2$$

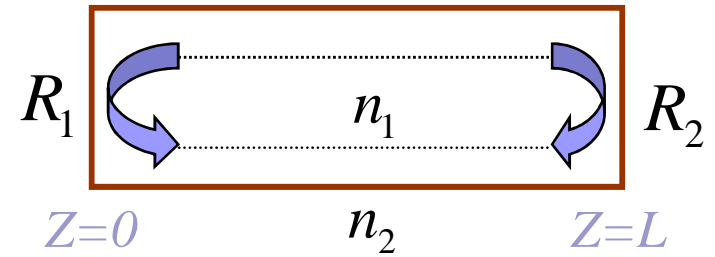

The electric field in the cavity is: $E(z) = E_0 \exp(j(\beta z - \omega t) + (g - \alpha) \cdot z/2)$

– g is the power gain, α is the power losses

– Factor of two because this is amplitude, not power

After one round-trip, the electric field become:

$$E(z + 2L) = E_0 \sqrt{R_1 R_2} \exp(j(\beta(z + 2L) - \omega t) + (g - \alpha) \cdot (z + 2L)/2)$$

The limiting condition for lasing is that: $E(z + 2L) = E(z)$

Both an amplitude and a phase condition for lasing:

- ν_m are the lasing longitudinal modes:

$$g_{th} = \alpha - 1/(2L) \ln(R_1 R_2)$$

assuming

$$\beta = 2\pi n / \lambda$$

$$\beta L = m\pi \Leftrightarrow \nu = \nu_m = (mc)/(2nL)$$

Optical Transmitter

Spectrum from a Laser Diode

- Laser start to “lase” if $g \geq g_{th}$

Simplest kind of semiconductor laser:

A Fabry-Perot laser

– Uses a Fabry-Perot interferometer

– Will lase in several modes simultaneously

$$\Delta\nu = \nu_m - \nu_{m-1} = \frac{c}{2Ln} \Leftrightarrow \Delta\lambda = \frac{\lambda^2}{2Ln}$$

Mode frequency spacing is

$\Delta\nu \approx 100\text{--}200$ GHz for a typical laser

Gaussian profile:

$$g(\lambda) = g(0) \exp\left[-\frac{(\lambda - \lambda_0)^2}{2\sigma^2}\right] \quad \sigma : \text{spectral width}$$

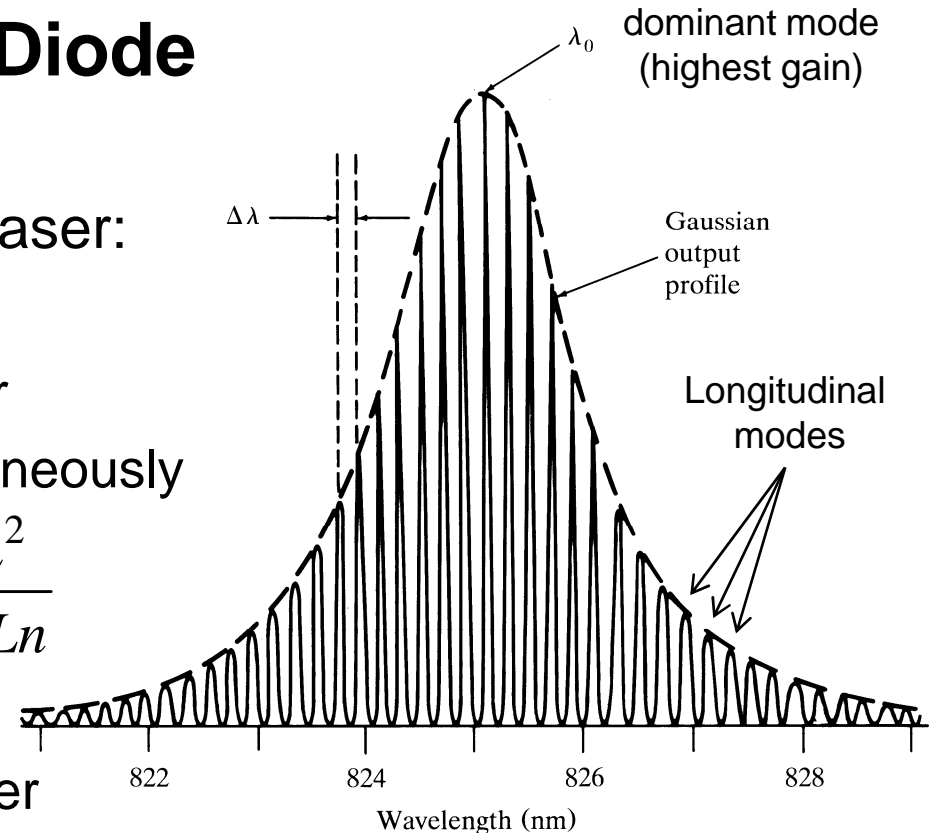

Optical Transmitter

Single-mode lasers

- Wavelength-dependent cavity loss \Rightarrow single-mode lasing

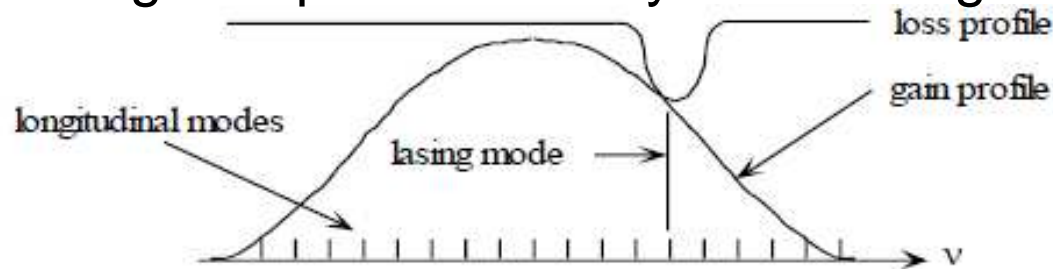

- Distributed feedback (DFB) laser (most common)
 - Wavelength-selective grating in the cavity
 - Can be temperature tunable (~ 5 nm)
- External-cavity laser
 - Uses a frequency-selective element outside the cavity
 - Widely tunable (~ 50 nm), narrow linewidth
- Vertical-cavity surface-emitting laser (VCSEL)
 - Light output orthogonal to substrate \Rightarrow easier to produce
 - Very good alternative to an LED

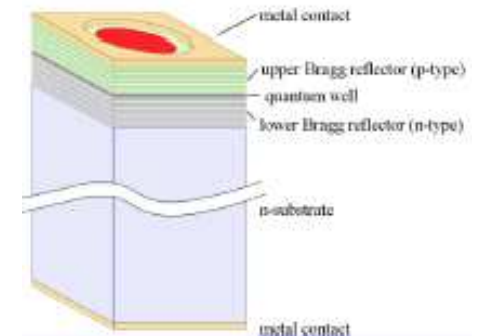
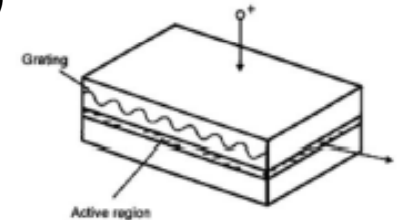

Optical Transmitter

The semiconductor laser rate equations

Describe the static and dynamic behavior of semiconductor lasers

- The number of photons and electrons are P , respective N
- Assuming a (transverse and longitudinal) single-mode laser

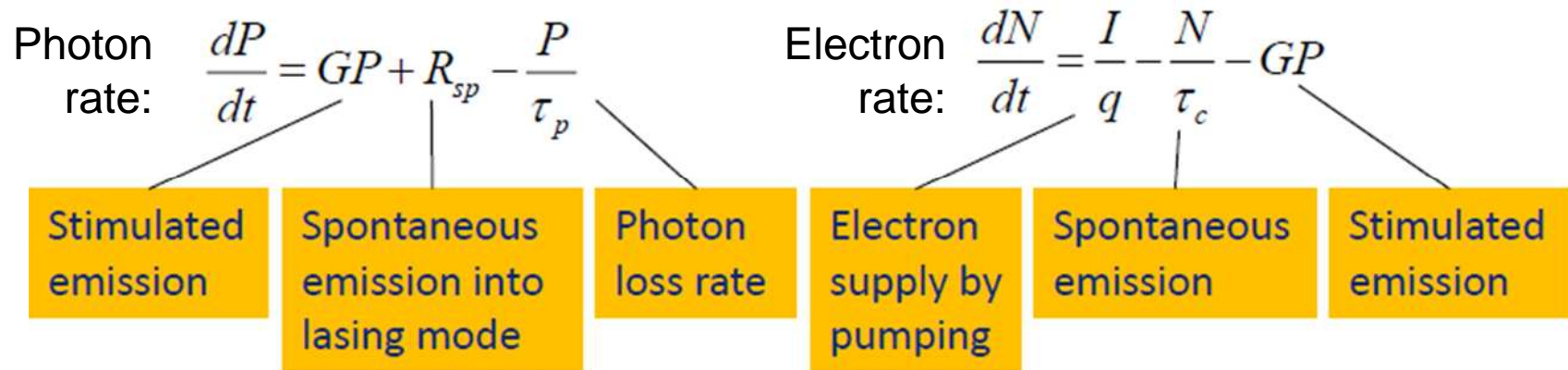

The net rate of stimulated emission is related to the rate of spontaneous emission

$$G = G_N (N - N_0)$$

- n_{sp} is around 2 for semiconductor lasers

$$R_{sp} = n_{sp} G$$

- The photon lifetime is

$$\tau^{-1} = v_g \left(\alpha - 1/(2L) \ln(R_1 R_2) \right)$$

At the threshold of lasing:

$$P \approx 0, \quad dP/dt \geq 0, \quad R_{sp} \approx 0$$

Optical Transmitter

CW (steady-state) operation

In steady-state, time differentiation yields zero ("d/dt = 0")

Neglect spontaneous emission for simplicity ($R_{sp} = 0$)

Use the rate equations to get

- For small currents: $G\tau_p < 1$, $P = 0$, $N = \frac{I\tau_c}{q}$
- At lasing threshold: $G\tau_p = 1$, $P \approx 0$, $N = N_{th} = N_0 + \frac{1}{G_N\tau_p}$, $I = I_{th} = \frac{qN_{th}}{\tau_c}$
- Above threshold: $G\tau_p = 1$, $P = \frac{\tau_p}{q}(I - I_{th})$, $N = N_{th} = \text{const}$, $I > I_{th}$

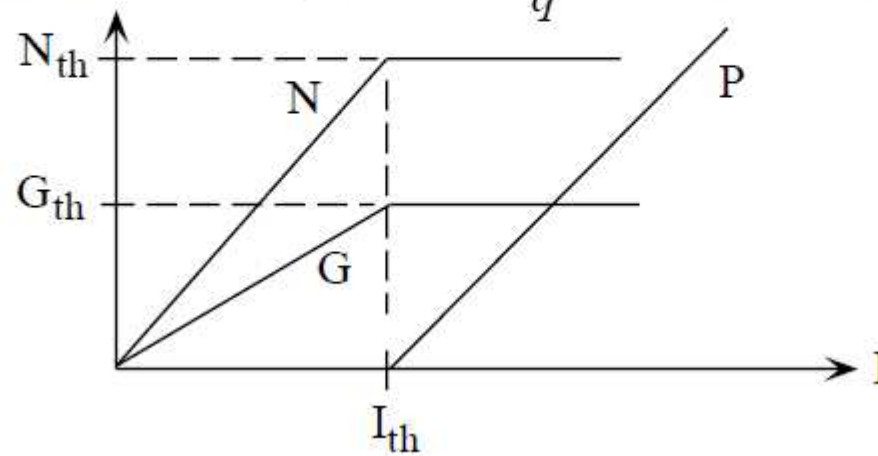

Optical Transmitter

P-I curves

The output power from one facet, assuming equal facet reflectivity R , is

$$P_e = \frac{1}{2} v_g \alpha_{\text{mir}} h \nu P = \frac{1}{2} v_g \frac{1}{L} \ln\left(\frac{1}{R}\right) h \nu P$$

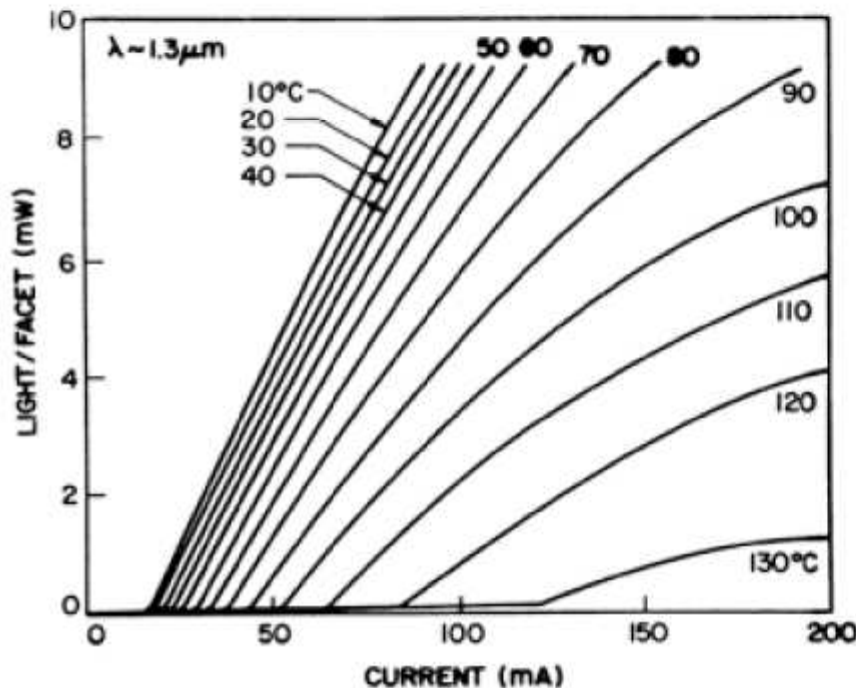

- Two types of degradation with increasing temperature
 - Threshold current increases
 - $P-I$ curves bend when injected current is increased
- The reasons are:
 - Increased non-radiative recombination
 - Increasing internal losses

Optical Transmitter

External quantum efficiency

External quantum efficiency = Number of photons emitted per radiative electron-hole pair recombination above threshold.

$$\begin{aligned}\eta_{ext} &= \frac{\eta_i (g_{th} - \bar{\alpha})}{g_{th}} \\ &= \frac{q}{E_g} \frac{dP}{dI} = 0.8065 \lambda [\mu\text{m}] \frac{dP(\text{mW})}{dI(\text{mA})}\end{aligned}$$

Note that:

$$\eta_i \approx 60\% - 70\%; \quad \eta_{ext} \approx 15\% - 40\%$$



Optical Transmitter

Modulation of Optical Sources

Optical sources can be modulated either directly or externally:

Direct modulation is done by modulating the driving current according to the message signal (digital or analog)

In **external modulation**, the laser emits continuous wave (CW) light and the modulation is done in the fiber

Notes:

- A communication link is established by transmission of information reliably. Optical modulation is embedding the information on the optical carrier for this purpose
- The information can be digital (1,0) or analog (a continuous waveform)
- The bit error rate (BER) is the performance measure in digital systems
- The signal to noise ratio (SNR) is the performance measure in analog systems

Optical Transmitter

Direct Modulation

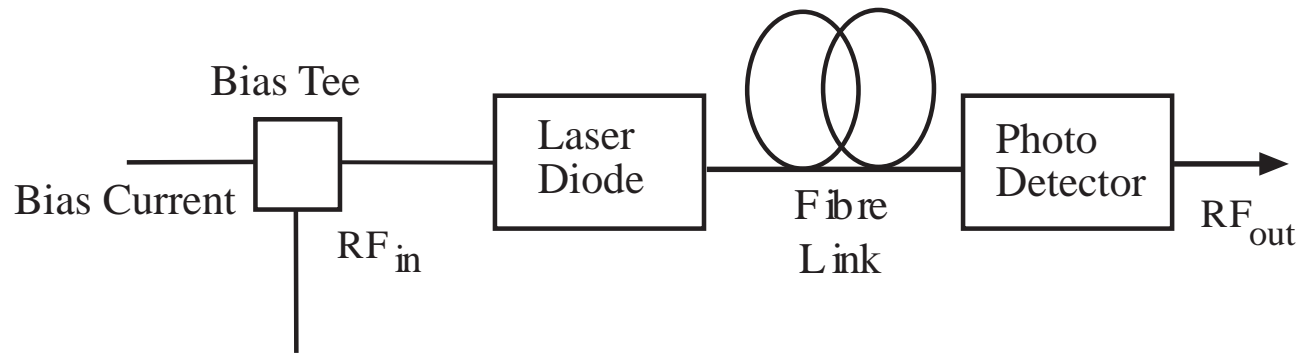

The message signal (ac) is superimposed on the bias current (dc) which modulates the laser. Robust and simple, hence widely used.

Issues: laser resonance frequency, chirp, turn on delay, clipping and laser nonlinearity

Optical Transmitter

Direct Modulation

With no signal input optical source has a bias current I_B and output power P_t . When an analog signal $s(t)$ is applied, the time-varying (analog) optical output is:

$$P(t) = P_t(t) [1 + m \cdot s(t)]$$

where $m = \text{modulation index}$

$$m = \Delta I / I_B$$

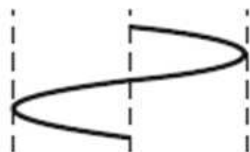
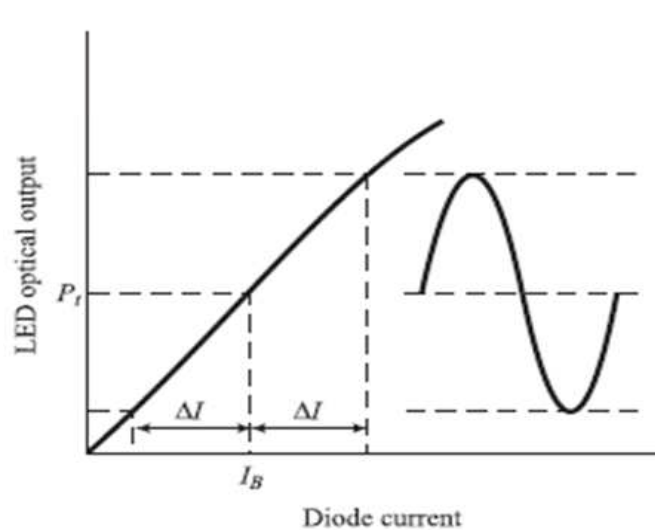

LED

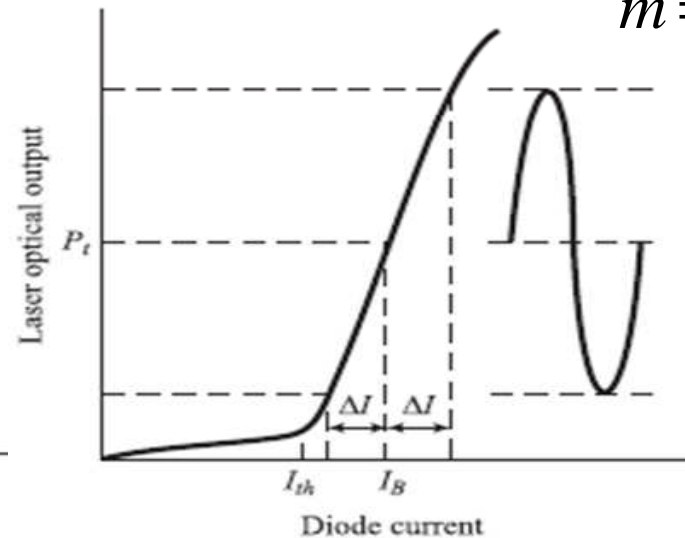

Laser diode

For LEDs $I_B' = I_B$

For laser diodes

$I_B' = I_B - I_{th}$

Optical Transmitter

Laser Digital Modulation (On Off Keying - OOK)

Internal Modulation: Simple but suffers from non-linear effects

When the driving current jumps from low ($I_1 < I_{th}$) to high ($I_2 > I_{th}$), (step input), there is a finite time before the laser will turn on:

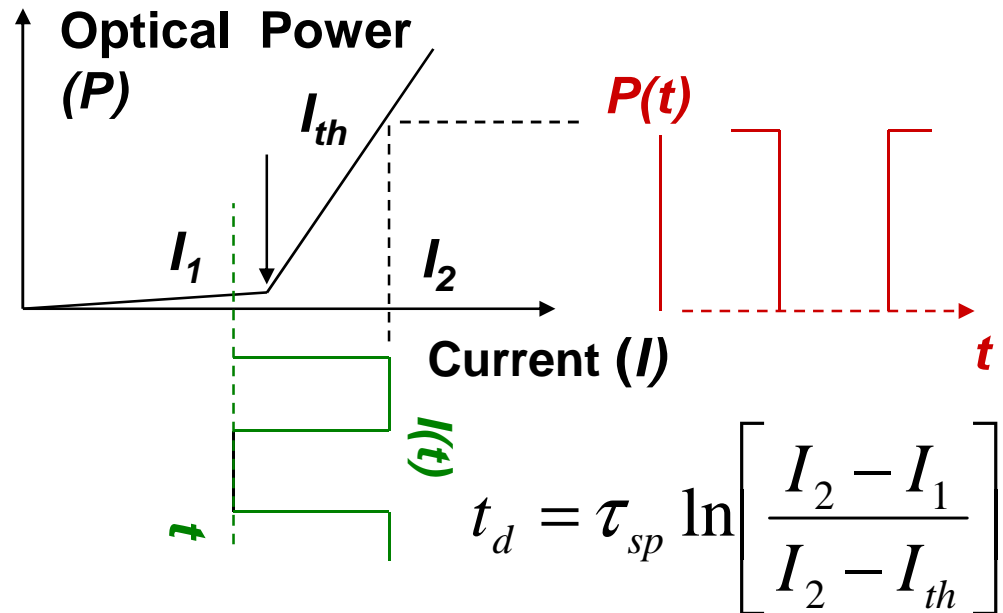

Most fundamental limit for the modulation rate:

→ the **photon life time** in laser cavity:

$$\frac{1}{\tau_{ph}} = \frac{c}{n} \left(\bar{\alpha} + \frac{1}{2L} \ln \frac{1}{R_1 R_2} \right) = \frac{c}{n} g_{th}$$

→ the **relaxation oscillation frequency**:

$$f = \frac{1}{2\pi} \frac{1}{\sqrt{\tau_{sp} \tau_{ph}}} \left(\frac{I}{I_{th}} - 1 \right)^{1/2}$$

Limitations of Direct Modulation

- Turn on delay and resonance frequency are the two major factors that limit the speed of digital laser modulation
- Saturation and clipping introduces nonlinear distortion with analog modulation (especially in multi carrier systems)
- **Nonlinear distortions** introduce higher order inter modulation distortions (IMD3, IMD5...)
- **Chirp**: Unwanted laser output wavelength drift with respect to modulating current that result on widening of the laser output spectrum.

Laser Noise

- **Modal (speckle) Noise:** Fluctuations in the distribution of energy among various modes.
- **Mode partition Noise:** Intensity fluctuations in the longitudinal modes of a laser diode, main source of noise in single mode fiber systems.
- **Reflection Noise:** Light output gets reflected back from the fiber joints into the laser, couples with lasing modes, changing their phase, and generate noise peaks. Isolators & index matching fluids can eliminate these reflections

Optical Transmitter

Noise in semiconductor lasers

- The carrier and photon numbers fluctuate
 - The generation process is quantized
- The main source of noise is spontaneous emission
- The phase of the noise is random
 - Perturbs both the phase and the amplitude
- Gives rise to a finite SNR
- The spectral width $\neq 0$
 - Limited coherence

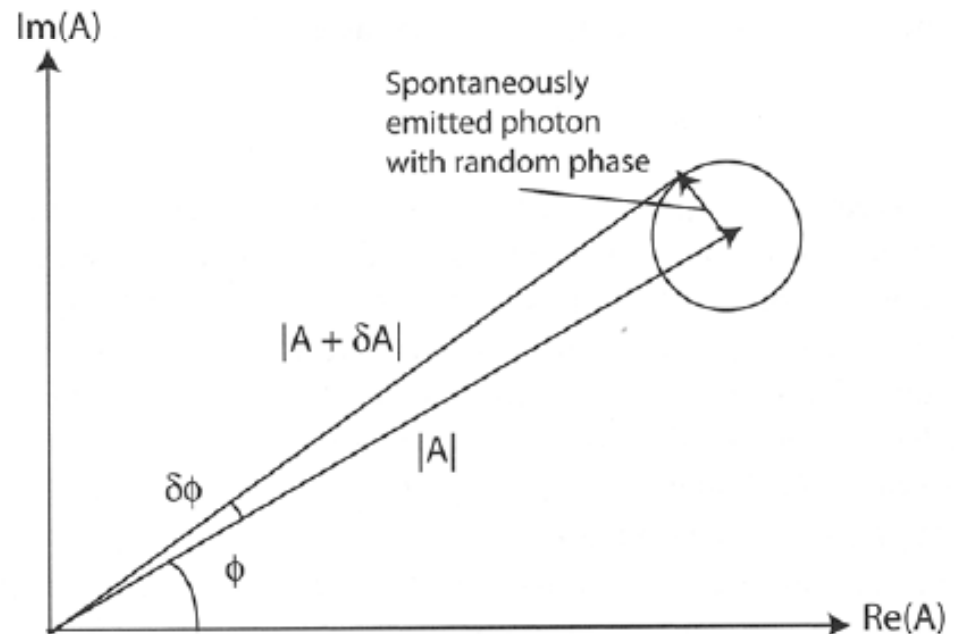

Optical Transmitter

Relative intensity noise (RIN)

We define the power fluctuation according to $\delta P(t) = P(t) - \langle P(t) \rangle$

The RIN spectrum is the **power spectral density** (PSD) of δP normalized to the square of the mean power

- Obtained from the rate equations with added noise terms
- Peaked close to the relaxation oscillation frequency

This is introduced using the auto-correlation of δP

- Use Wiener–Khinchin's theorem

$$C_{pp}(\tau) = \langle \delta P(t) \delta P(t + \tau) \rangle / \langle P(t) \rangle^2$$

$$\text{RIN}(\omega) = \int_{-\infty}^{\infty} C_{pp}(\tau) e^{-i\omega\tau} d\tau$$

The SNR is mean power/RMS noise

- $\text{SNR} = [C_{pp}(0)]^{-1/2}$
- Obtained as $1/(\text{integral of PSD})$
- Typically 20–30 dB

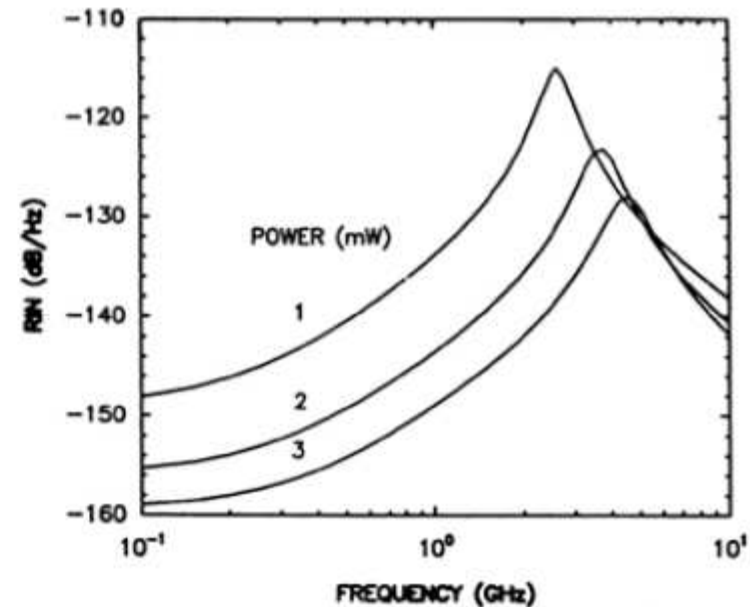

Optical Transmitter

External Modulation

The optical source injects a constant-amplitude light signal into an external modulator.

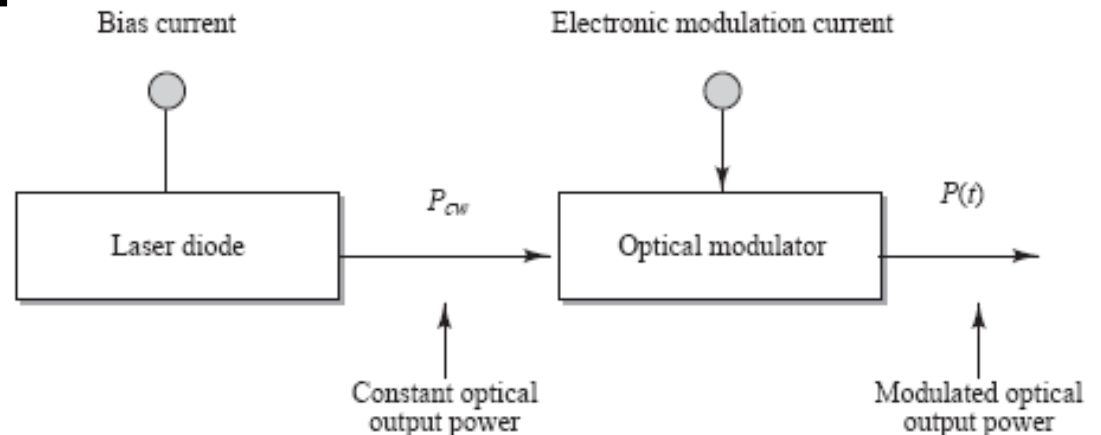

The electrical driving signal changes the optical power that exits the external modulator:

- **the electro-optical (EO) phase modulator** (Mach-Zhender Modulator - MZM) , typically is made of LiNbO_3 .
- **the electro absorption modulator (EAM)**, based on the Franz–Keldysh effect.

Optical Transmitter

Mach-Zehnder Principle

Total relative phase difference between the two interfering signals

Phase shift in the upper arm output is $\beta \cdot \Delta L + m\pi$

Phase shift in the lower arm output is $\beta \cdot \Delta L$

If m is even \rightarrow constructive interference (in phase)

If m is odd \rightarrow destructive interference (opposite phase)

Light intensity modulation will result for all other values of m .

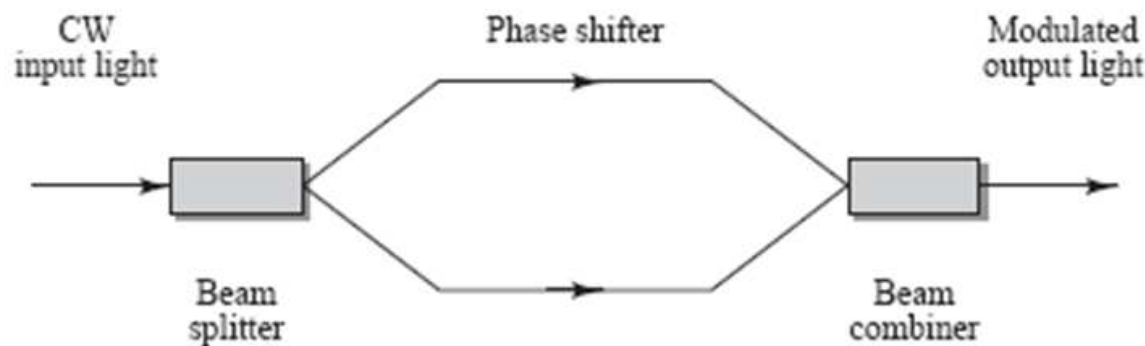

Optical Transmitter

Electro Absorption Modulator

An EAM is a semiconductor external modulator that changes its absorption spectrum in presence of electric field, (due changes in the bandgap energy).

The EAM are made in the form of a waveguide with electrodes for applying an electric field in a direction perpendicular to the modulated light beam.

EAM can operate with lower voltages and at very high speed (tens of GHz)

EAM can be integrated with a DFB laser diode on a single chip to form a data transmitter in the form of a photonic integrated circuit.

EAM can also be used as Photo Detectors in the reverse mode

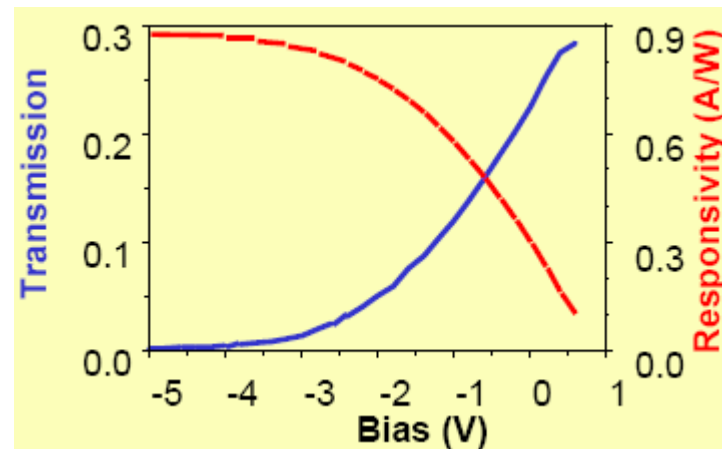
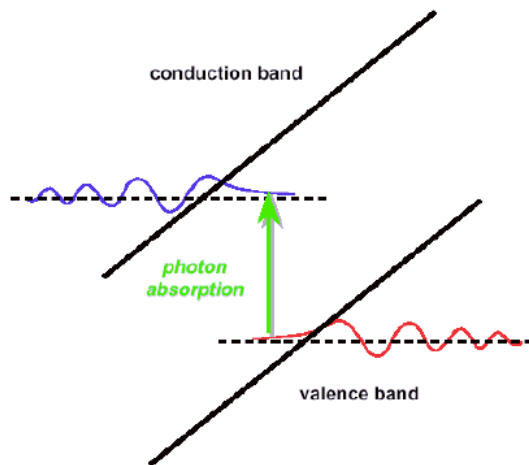

Optical Transmitter

Distributed Feedback Laser (Single Mode Laser)

The optical feedback is provided by fiber Bragg Gratings

Only one wavelength get positive feedback.

Fiber Bragg Grating is an optical notch band reject filter.

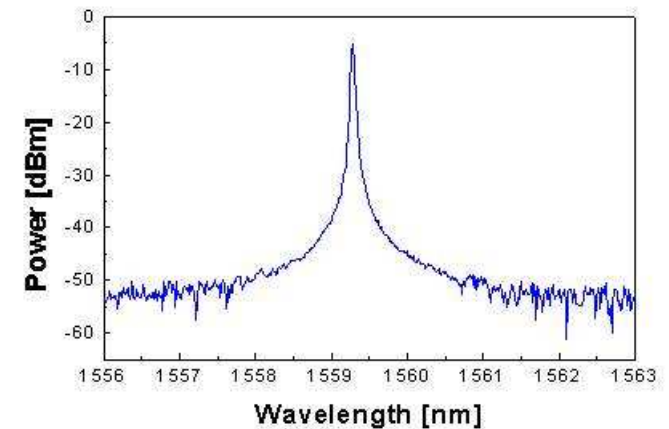
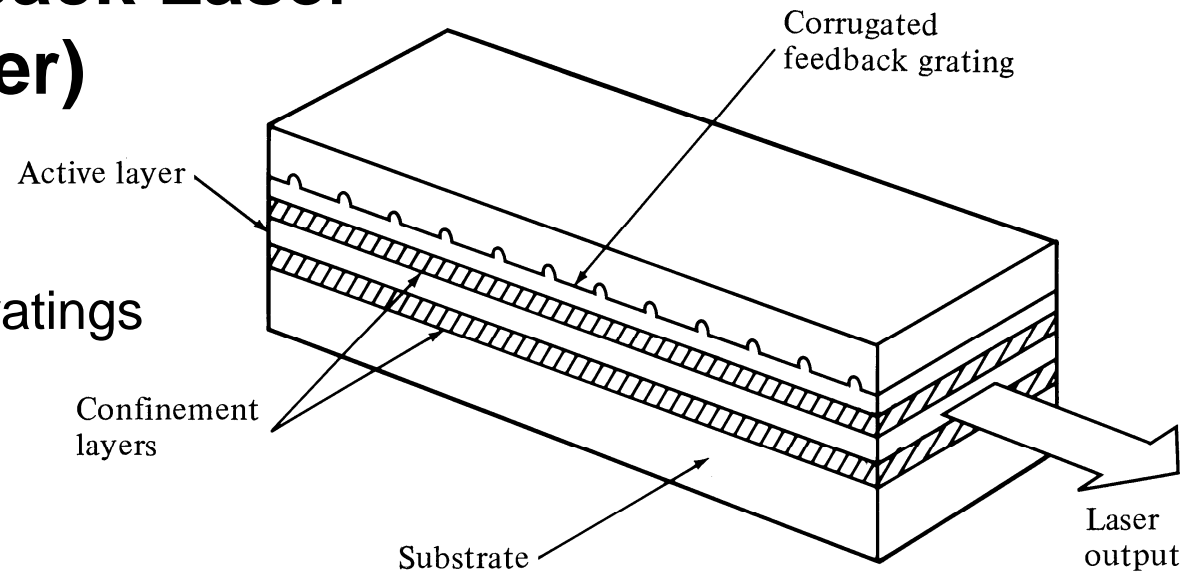

Optical Transmitter

Transmitter Packages

There are a variety of transmitter packages for different applications. One popular transmitter configuration is the *butterfly package*.

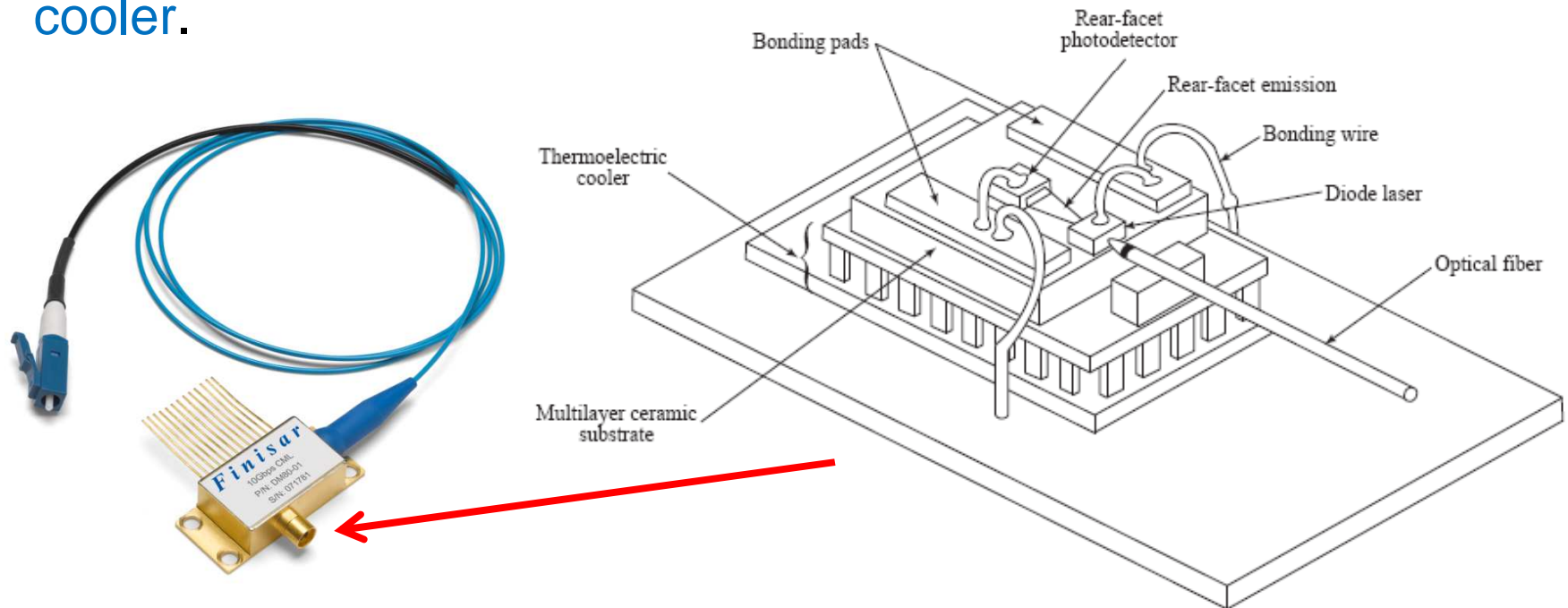

This device has an attached fiber fly lead and components such as the diode laser, a monitoring photodiode, and a thermoelectric cooler.



Optical Transmitter

Transmitter Packages

Three standard fiber optic transceiver packages

<p>SFP</p> 	<ul style="list-style-type: none">• Short and long wavelength WDM use• Datacom applications: Fast/Gigabit Ethernet and 1x,2x,4x Fibre Channel• Telecom applications using OC-3/STM-1, OC-12/STM-4, and OC-48/STM-16 across all distances• Distances from very short links up to 100 km
<p>SFF</p> 	<ul style="list-style-type: none">• Short and long wavelength use• Datacom applications for Gigabit Ethernet and 1x,2x,4x Fibre Channel• Telecom applications using OC-3/STM-1, OC-12/STM-4, and OC-48/STM-16 across all distances• Distances from very short links up to 80 km
<p>XFP</p> 	<ul style="list-style-type: none">• Short and long wavelength DWDM use• Datacom applications using 10G Ethernet and 10x Fibre Channel• Telecom applications using OC-192/STM-64• Distances up to 80 km• Supports bit rates up to 11.3 Gb/s